

WORCESTER GREENSTORE 6kW, 7kW, 9kW & 11kW Combi

HEAT PUMP

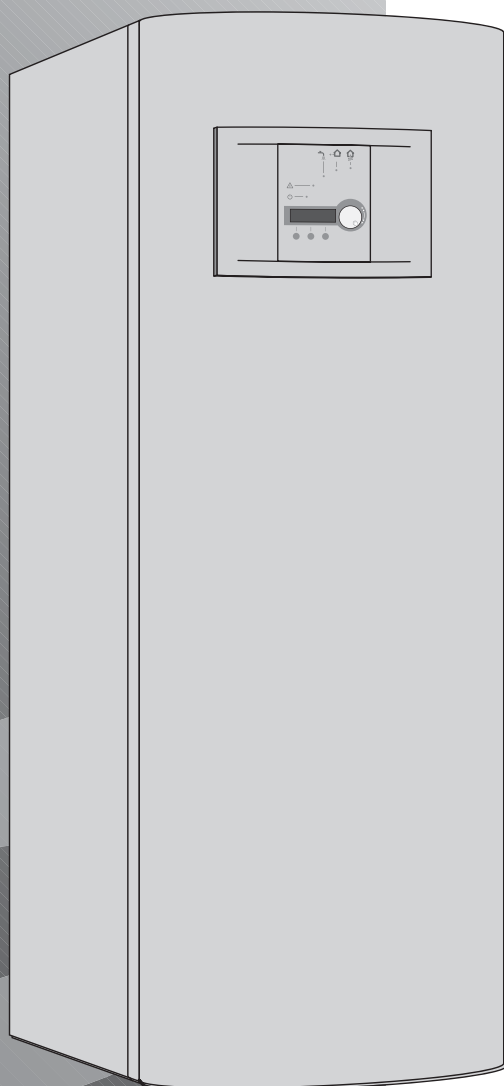

GB/IE

USER MANUAL

 **WORCESTER**
Bosch Group

benchmark

Table of contents

<i>BUILDING REGULATIONS</i>	3
Important information	4
<i>Technical support</i>	4
How the heat pump works	5
<i>Technology in and around the heat pump</i>	5
Component parts of the heat pump	7
<i>Greenstore Combi</i>	7
Rego 637W Control unit	8
<i>The control unit's two methods to control the heat pump</i>	9
Control panel	10
<i>Controls and status indicators</i>	10
<i>Menu dial</i>	11
<i>How to use the control panel</i>	11
Basic functions (Customer level 1)	11
<i>Menu outline for Basic functions (Customer level 1)</i>	12
<i>Select scrolling information on the menu display</i>	12
<i>Set the heating</i>	13
<i>Set the required room temperature</i>	16
<i>Set the heat pump for extra hot water</i>	16
<i>Heating and hot water settings</i>	17
<i>Read the temperatures on the heat pump</i>	17
Extra functions (Customer level 2)	19
<i>Menu outline for Extra functions (Customer level 2)</i>	19
<i>Temperature settings</i>	20
<i>Set extra heat curve with mixing valve</i>	21
<i>Hot water settings</i>	22
<i>Timer control</i>	22
<i>Reading operating times on the heat pump and electric heater</i>	23
<i>Set the time and date</i>	24
<i>Alarms given by the heat pump</i>	25
<i>Return to the heat pump's factory settings</i>	25

BUILDING REGULATIONS

This appliance must be installed and serviced only by a competent person in accordance with the current: IEE Regulations, Building Regulation, Building Standards (Scotland) (Consolidation), Building Regulations (Northern Ireland), local water by-laws, Health & Safety Document 63S (The Electricity at Work Regulations 1989), IS 813 (Eire) and other local requirements.

The relevant Standards should be followed, including:

BS7074:1 : Code of practice for domestic and hot water supply

EN:12828 : Central heating for domestic premises

BS7593 : Treatment of water in domestic hot water central heating systems

BS EN 14511

BS EN 814

BS EN 378

The Health and Safety at Work Act 1974

The Management of Health and Safety at Work Regulations 1999

The Construction (Health, Safety and Welfare) Regulations 1996

The Construction (Design and Management) Regulations 1994

The Lifting Operations and Lifting Equipment Regulations 1998

Where no specific instruction is given, reference should be made to the relevant codes of Practice.

Potable water:

All seals, joints, compounds (including flux and solder) and components used as part of the secondary domestic water system must be approved for use with potable water supplies.

PRODUCT CONTENTS LIST

Greenstore Combi Heat Pump.

Components included in delivery:

Rubber feet

Outdoor sensor T2 (GT2) with cable

Room sensor T5(GT5)

Return sensor T1 (GT1)

4 bar Pressure Relief Valve

Valve with filter

Circlip pliers

Drain plug

Ball valve

Expansion vessel

Filling link with insulation and filter

Literature pack:

User manual

Installation manual

Guarantee card

Unvented cylinder kit:

DHW expansion vessel

Expansion Vessel Hose

Wall mounting kit for expansion vessel

High flow rate inlet control set

Acetal tundish

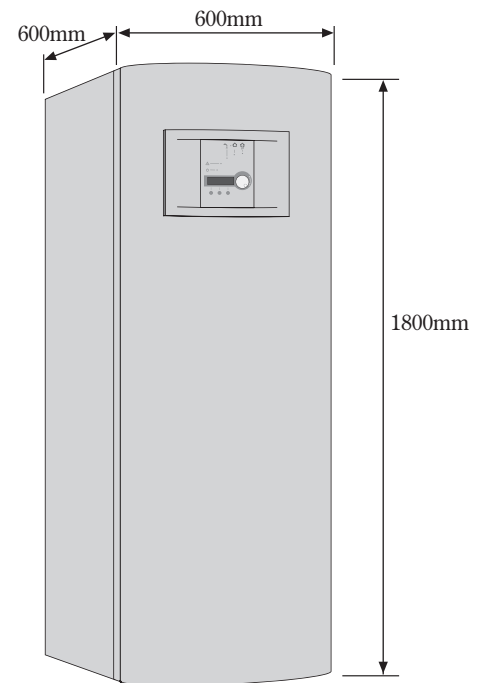

User manual for the Worcester Greenstore Combi heat pumps

Worcester, 09.01.07

Part number: 8-716-113-341

Issue: a

Copyright © 2007

Important information

Your new Greenstore Combi heat pump represents a new generation of heat pump from Worcester. It contains numerous functions to control the temperature and production of hot water in the house. The Rego 637W control unit is the brains of the heat pump. The Rego 637W includes a control and monitoring function that stores important settings about the heat pump's operation and maintenance. The settings are made by the installer and the user via a control panel on the front of the heat pump. Settings intended for the user, are presented under the headings Basic functions and Extra functions.

When the heat pump has been installed and started there are a number of points you should check regularly. For initial setup, commissioning and further fault advice, you should contact your installer. This manual describes each step in detail.

Technical support

For technical support please contact:

Technical Pre & Post sales
Tel: 08705-266241
Fax: 01905-752741



Note

It is important as the user that you read through these instructions. Under no circumstances should the user make settings that are designed for the installer.

How the heat pump works

The heat pump collects stored solar energy

The heat pump has been manufactured for easy and reliable use as well as to provide your house with inexpensive and environment friendly heating. The easiest way to describe how a heat pump works is to say it works like a refrigerator, but in reverse. In a refrigerator, heat is moved from the inside to the outside. In a heat pump, heat stored in the ground, rock or water, is moved into the house. The heat pump collects the stored solar energy. The heat is transferred into the house via a collector system. The temperature is then increased in the heat pump and the heat is distributed to the house heating system.

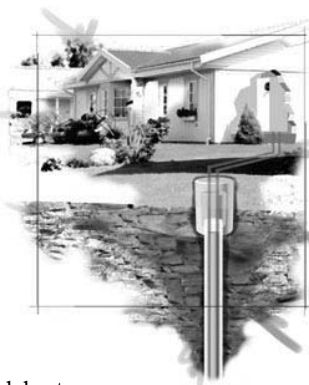

Rock heat



Soil heat



Lake heat

Technology in and around the heat pump

The heat pump consists of four main parts:

1. **Evaporator**
The evaporator turns the refrigerant to gas and transfers heat from the heat transfer fluid to the refrigerant circuit.
2. **Condenser**
The condenser turns the vapour to fluid again and transfers the heat to the heating system.
3. **Expansion valve**
Lowers the pressure of the refrigerant.
4. **Compressor**
The compressor increases the pressure and temperature of the refrigerant.

These four main parts are linked in three circuits. A refrigerant circulates in the heat pump, which in some parts of the circuit is in a liquid state and in other parts in a gaseous state. Read more about the properties of the refrigerant in the text box to the right.

See the detailed description of the technologies used in the heat pump on the next page.



Note

Boiling point in relation to the pressure:

The boiling point of different liquids varies with pressure, the higher the pressure, the higher the boiling point. For example, water boils at +100°C at normal pressure. Double the pressure and water boils at +120°C. Half the pressure and water then boils at +80°C. The refrigerant in the heat pump acts in the same way, the boiling point changes when the pressure changes. However, the boiling point of the refrigerant is as low as approximately -40°C at atmospheric pressure. Consequently, it is also suitable for low heat source temperatures.

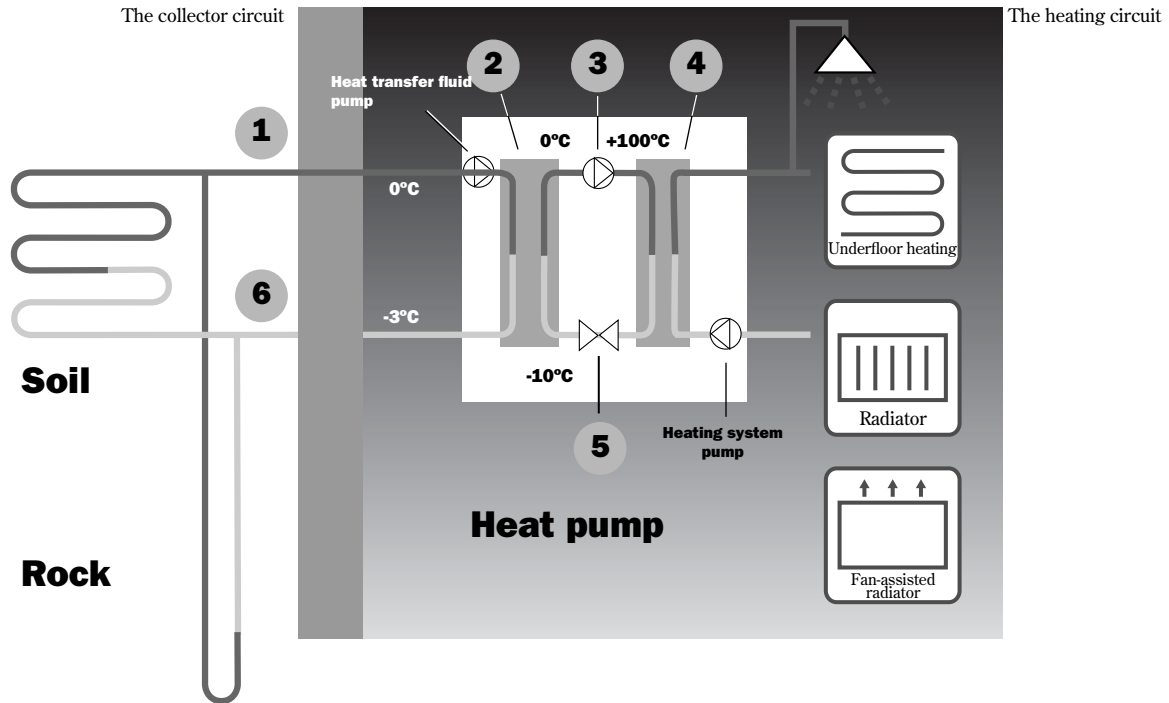

- 1 Heat transfer fluid in. The heat pump collects stored solar energy. It contains a heat transfer fluid which is a solution of water and glycol. This antifreeze mixture collects the heat from the earth or rock and is fed into the evaporator. The temperature is on average around 3-5°C.
- 2 In the evaporator, the heat transfer fluid meets the refrigerant. At this stage, the refrigerant is in a fluid state and is at approximately -10°C. When the refrigerant meets the heat transfer fluid it starts to boil. It then forms a vapour, which is fed into the compressor. The temperature of the vapour is around 0°C.
- 3 The pressure of the refrigerant increases in the compressor and the vapour temperature rises from 0°C to approximately +125°C. The hot gas is then forced into the condenser.
- 4 The condenser transfers the heat to the heating system (underfloor heating or perhaps radiators) and the hot water system. The vapour is cooled in the condenser and becomes liquid. The pressure in the refrigerant is still high when it reaches the expansion valve.
- 5 The refrigerant pressure is lowered in the expansion valve. At the same time, the temperature also drops to approximately -10°C. When the refrigerant passes the valve and the evaporator it changes to vapour again. The expansion valve also regulates the amount of refrigerant fed into the evaporator.
- 6 The heat transfer fluid is led out from the heat pump to the ground loop to collect new stored solar energy. The temperature of the fluid is approximately 3°C cooler than the flow in.

Component parts of the heat pump

Greenstore Combi

Three-way valve

The valve switches between heating the heating water and domestic hot water.

Venting nipple

The nipple is used to vent the primary water in the hot water cylinder.

Hot water cylinder

The cylinder is double-shelled and holds approximately 185 litres of domestic hot water and 40 litres of primary water.

Electric heater

The electric heater is used to provide extra output in cold weather conditions, with large water consumption and at hot water peaks.

Reset button

Press in the button if the overheat protector on the electric cassette has tripped. The button is located on the side.

Condenser (not visible)

The condenser condenses the refrigerant vapour to a liquid again and transfers the heat to the heating system.

Heat carrier pump

The pump ensures the primary water circulates within the heating system or domestic hot water systems.

Flexible hoses

The hoses counteract vibrations in the heat pump.

Compressor

The compressor increases the pressure of the refrigerant. The temperature of the vapour increases from 0°C up to approximately +130°C. The compressor is insulated to reduce the noise level.

Sight glass

Sight glass to check the level in the refrigerant circuit. Gas bubbles should not form continuously in the sight glass when the heat pump is running. However, there might be bubbles for several minutes when the heat pump is started. These will then disappear

Electrical connections

Connections for the mains supply as well as sensors.

Control panel

The control panel has a back lit menu display with four rows of text information, three buttons and a dial.

Distribution box

The distribution box is enclosed. It houses a reset function for the motor cut-out as well as miniature circuit breakers (MCB) for the heat pump and electric heater.

Evaporator

The evaporator evaporates the refrigerant to gas and transfers heat from the heat transfer fluid to the refrigerant circuit.

Heat transfer fluid pump

The pump is insulated and features an anti-corrosive finish. It ensures the heat transfer fluid circulates from the energy source to the heat pump.

Control unit

The control unit is enclosed. It controls and monitors all heat pump functions.

Expansion valve

Lowers the pressure and regulates the amount of refrigerant that enters the evaporator.

Softstart

Reduces the compressors starting current.

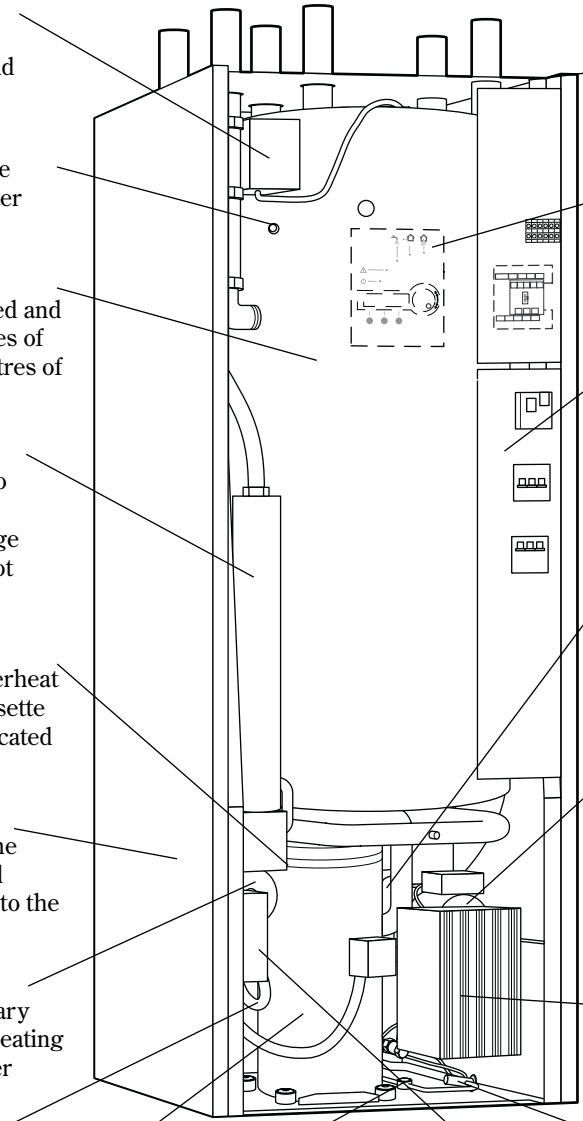

Rego 637W Control unit

The control unit is the brains of the heat pump. It makes sure the heat pump gives the best energy savings. The control unit controls and monitors the heating and hot water supply in your house. The monitoring function is especially important. It shuts down the heat pump in the event of operational abnormalities so that no critical parts are damaged.

Electric heater gives more output

If the heat pump cannot manage to heat the house by itself, for example, there is a considerable drop in the outdoor temperature, the control unit ensures the additional electric heater is connected. The heat pump and electric heater help to maintain the temperature required in the house. The electric heater only adds the output necessary for the heat pump to be able to produce the right temperature. When the heat pump can once again manage heating on its own the electric heater is automatically disconnected.

Domestic hot water (DHW) is given priority over central heating water

The integrated hot water cylinder is fitted with a sensor that measures the temperature of the hot water. The Rego 637W ensures that priority is given to the domestic hot water (DHW) over the heating demands.

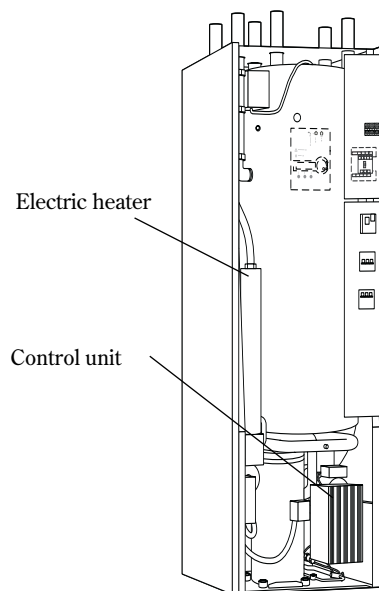

The control unit's two methods to control the heat pump

The control unit uses two different methods to control the heat pump. These two methods are A or B, as below:

A: Control with outdoor sensor

A sensor is installed outside on a North facing wall of the house. Control with an outdoor sensor means that the heat pump automatically regulates the heating in the house depending on the outdoor temperature. If the outdoor temperature drops, the radiators/underfloor heating inside the house will become warmer.

The user determines the response from the heat pump in relation to the outdoor temperature, with the help of a number of settings such as selecting the heat curve on the control unit. Further explanation is given later in this manual.

B: Control with outdoor sensor supplemented with room sensor

Control with an outdoor sensor supplemented with a room sensor means that you also place a sensor in a reference position inside the house. This is connected to the heat pump and provides the control unit with information about the room temperature. The signals affect the control unit's settings (heat curves) and ensure the heat pump gives the best possible energy savings.

**Note**

It is only the room where the room sensor is located that can influence regulation of the temperature.

**Note**

The room sensor influence is inhibited 2 hours after using clock setting for the heating, or any type of external control of the heat pump.

Control panel

All settings are made on the control panel. It also displays heat production statistics and information about different alarms. When you have made your settings, the control panel makes sure they are saved in the control unit.

Controls and status indicators



Power switch (ON/OFF)

Indicator on: Mains power ON.
Indicator flashes: Mains power OFF.



Operating status

Indicator on: The heat pump (compressor) is operational.



Electric heater status

Indicator on: The heat pump is using additional heat from an electric heater.



Hot water status

Indicator on: The heat pump is heating DHW in the cylinder.
Indicator flashes: The heat pump has a hot water peak or is producing extra DHW.



Alarm status

Indicator flashes: A fault has occurred in the heat pump.
Indicator on: The alarm has been acknowledged by the end user, but the fault remains. (See section; What to do if a fault occurs).

Temp. incr. /
decr.



Heat

Pressing once gives a shortcut to the most frequently used temperature settings.

Info



Info

Pressing once gives continuous information about the heat pump and electrical heater operating conditions.

Menu



Menu

Press once to enter the main menu.
The main menu contains all the setting menus and temperature displays.

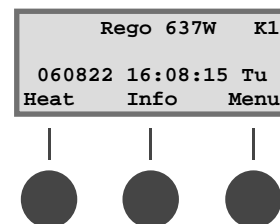
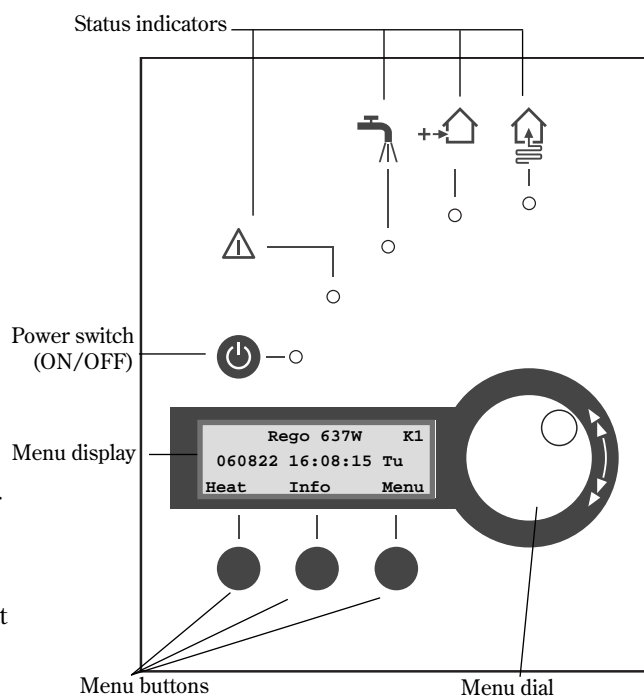

Menu dial

The menu dial is used to scroll through the menu display windows. Turn the menu dial clockwise (to the right) to move down through the menus. Turn the menu dial anti-clockwise (to the left) to move up through the menus. You also determine the values of different settings by using the dial.

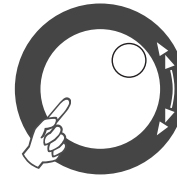

The menu display gives you information and the chance to make settings. You can:

- Choose different temperature and hot water settings.
- Choose extra hot water and the holiday function.
- See alarm causes and receive corrective instructions.
- Obtain operating statistics.

Initial menu display



How to use the control panel

The principle of the control panel is based on the user using three menu buttons and a menu dial to move between the different menus and settings. On the lower row of the menu display you will always see information about the significance of the buttons. The function of the buttons changes depending on which window you are currently in.

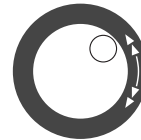

+

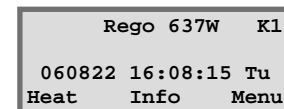

Example

If, from the initial menu, you press the Heat button, you will access the menu Temp. incr. / decr. . In this menu you can increase and decrease the heating in the house. Note that the significance of the buttons has now changed. You can either return to the initial menu by pressing the Return button or you can choose to change the heating setting in the house by pressing the Adjust button. If you press the Adjust button you can increase or decrease the heating in the house by using the menu dial. Save your adjustment by pressing the Save button.

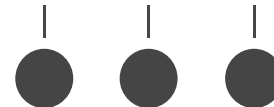
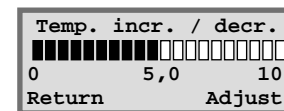

Basic functions (Customer level 1)

Basic functions (Customer level 1) are the functions most frequently used and the ones you have the most benefit of. You reach the basic functions by pressing one of the Heat, Info or Menu buttons in the initial menu. The designation K1 in the upper right corner indicates you are in Basic functions - Customer level 1.

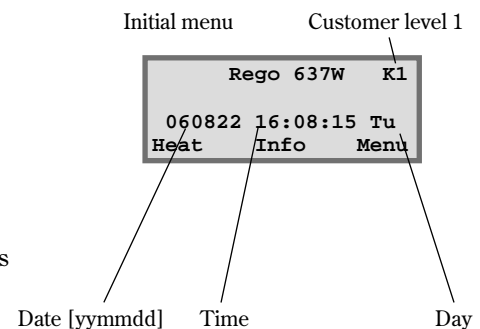

Menu outline for Basic functions (Customer level 1)

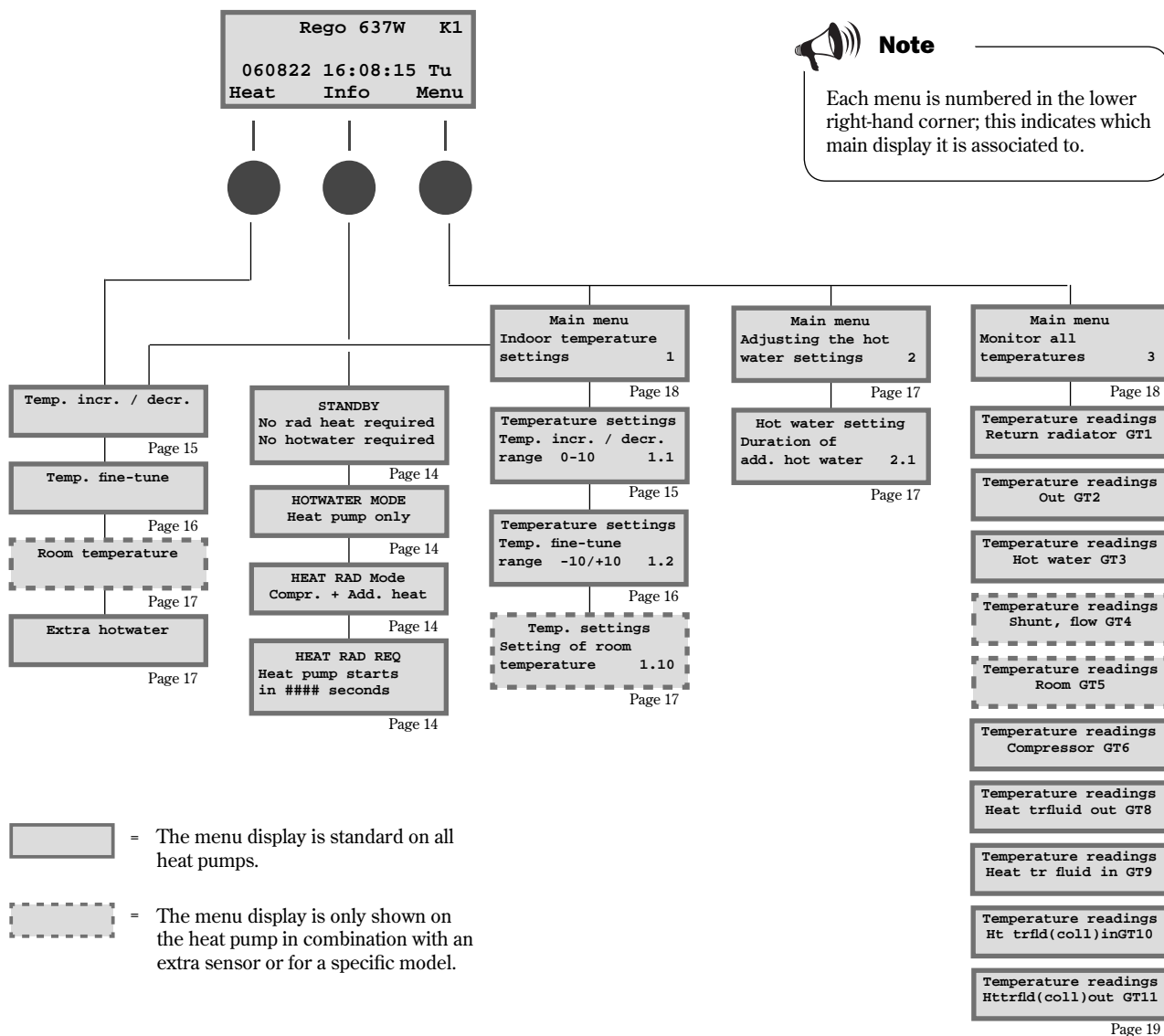

Select scrolling information on the menu display

If you press the Info button in the initial menu, you will receive continuous information about the heat pump's operation and working temperatures. This is what to do:

Press the Info button in the initial menu. The following windows are displayed:

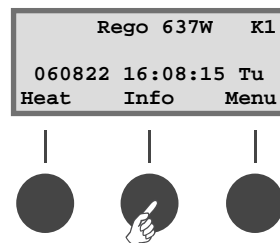

The heat pump is in standby mode.

```

STANDBY
No rad heat required
No hotwater required

```

The heat pump is producing hot water. The present temperature and temperature at which the heat pump will stop are shown. Note that the stop temperature is read at the bottom of the hot water cylinder therefore, the domestic hot water is a few degrees warmer in the top of the cylinder.

```

HOTWATER MODE
Heat pump only
Stop temp.      53,0°
Present temp    42,0°

```

The heat pump and electrical heater are running.

```

HEAT RAD MODE
Compr. + Add. heat
Stop temp.      45,0°
Present temp    44,0°

```

The heat pump has received signals that it should produce heating. It now waits for the restart time to countdown to zero.

```

HEAT RAD REQ
Heat pump starts
in 320 seconds

```

Return to the initial menu by pressing one of the buttons or turn the dial.

Set the heating

It is easy to set the heating level on the heat pump. However, before it is explained how to do this it is important to understand the relation between the outdoor temperature, return temperature and heat curve slope. The easiest way to explain the relation is with a heat curve.

Heat curve

The heat curve is used to set the indoor temperature. The heat pump is controlled by the outdoor temperature. When the weather becomes colder, the heat pump ensures more heating is produced automatically.

Return temperature:

The return temperature is the temperature of the water that returns to the heat pump from the radiators/underfloor heating. The flow temperature of the heat pump is normally 7-10°C higher than the return temperature. For instance, when the outdoor temperature is -10°C and curve 4 is set, the pump attempts to keep the return water at approximately 40°C.

Outdoor temperature:

The outdoor temperature determines how much heating the heat pump should produce. A sensor placed outdoors sends signals to the control unit, which then adjusts the heat pump. The sensor must be fitted to a North facing wall outdoors.

Curve slope:

The curve slope can be changed to increase or decrease the heating in the house. The scale is between 0-10.



Note

On delivery the heat pump curve slope is set to position 4. This means that the return temperature is +35°C when it is 0°C outdoors.

Change the curve slope

The heat pump's production of heat is adjusted by increasing or decreasing the curve slope in the Temp. incr. / decr. menu. This is especially effective in cold weather conditions.

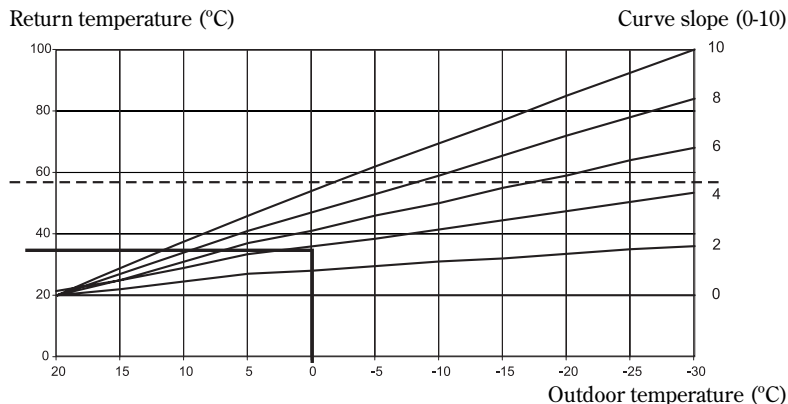

Curve slope:
 2-4 Normal setting for floor heating.
 4-6.5 Normal setting for radiators.
 7-10 Abnormal high setting.

Curve slope 4 gives a return temperature of +35°C when it is 0°C outdoors. If the outdoor temperature drops the return temperature increases. The colder the outdoor temperature the higher the return temperature. At an outdoor temperature of approximately -30°C the curve slope has nearly reached the limit value (+57°C) for the return temperature.

Dashed line:

If the return temperature exceeds 57°C an alarm is given and the compressor switches off. The heat pump starts automatically when the return temperature falls below 57°C.

In cold weather (below +5°C):

If the indoor temperature, when it is colder than +5°C outdoors, is not satisfactory, the slope of the heat curve should be changed as follows:

1. Press the Heat button in the initial menu.

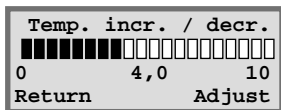

2. Press the Adjust button.
3. Turn the menu dial clockwise to increase the heating.
Turn the menu dial anti-clockwise to lower the heating.
(Adjust in small increments, 0.2-0.6 units, is usually enough.)

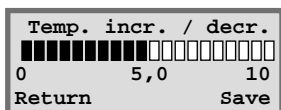

4. Save the new value by pressing the Save button.



Note

Wait at least one day when increasing or decreasing the heating before making a new adjustment.

If it is still difficult to get a comfortable indoor temperature at an outdoor temperature around 0°C, despite several attempts, adapt the heat curve.

Read about how to adapt the curve in the section Extra functions – Customer level 2 / Temperature settings / Adapting the heat curve.

Fine-tune the heat curve

The heat curve can also be fine-tuned. Fine-tuning means that the heat curve is offset in parallel. Fine-tuning is done from the Temp. fine-tune menu. The diagram for fine-tuning shows how the dashed line has been offset upwards in parallel. This means the heating has been fine-tuned in a positive direction and the heat pump will be instructed to maintain a higher temperature on the return water at all outdoor temperatures.

Return temperature (°C)

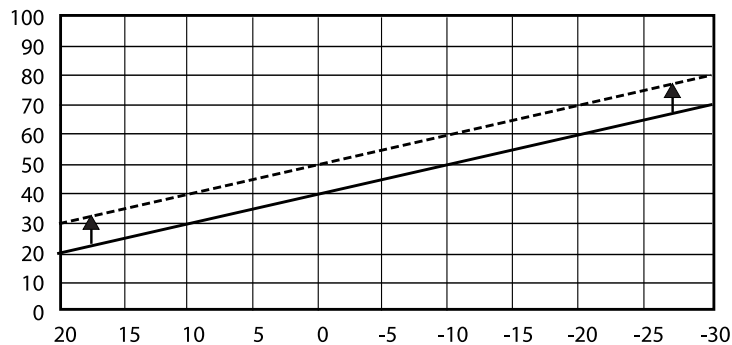

By using the menu dial on the control panel the fine-tuning line has been moved up so the heat pump produces more heat.

In warm weather (above +5°C):

If the indoor temperature is not satisfactory when it is above +5°C outdoors, the curve may be offset in the Temp. fine-tune menu as follows:

1. Press the Heat button in the initial menu.
2. Turn the menu dial clockwise until you reach the menu Temp. fine-tune.

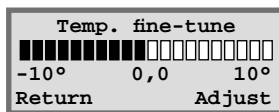

3. Press the Adjust button.
4. Turn the menu dial clockwise to increase the heating. Turn the menu dial anti-clockwise to lower the heating. Adjust in small increments, 0.2-0.6 units, is usually enough.
5. Save the new value by pressing the Save button.

Set the required room temperature

If a room sensor is connected to the heat pump the temperature of the room can be set using the Room temperature menu, or by using the Extra functions menu (Customer level 2).

To set the room temperature::

1. Press the Heat button in the initial menu.
2. Turn the menu dial clockwise until the Room temperature menu is displayed.

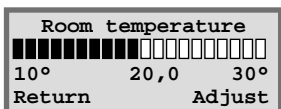

3. Press the Adjust button.
4. Turn the menu dial clockwise to increase the room temperature. Turn the menu dial anti-clockwise to lower the room temperature.
5. Save the new value by pressing the Save button.



Note

The example describes how to set the required room temperature with the help of a connected room sensor. The range is 10°C to 30°C.

Set the heat pump for extra hot water

Extra hot water can be obtained by temporarily increasing the temperature of the water in the hot water cylinder. This may be appropriate when, for example, a large number of people need to shower. This function may be needed for long demands for hot water.

1. Press the Heat button in the initial menu.
2. Turn the menu dial clockwise until you reach the menu Extra hotwater.

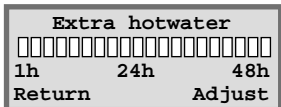

3. Press the Adjust button.
4. Turn the menu dial clockwise to choose the number of hours that the electric heater should be on (e.g. 24 hours).

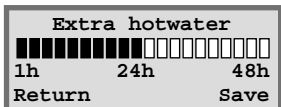

5. Save the new value by pressing the Save button.



Note

When the set time has elapsed the setting must be repeated to get extra hot water again.

Heating and hot water settings

Move to the temperature settings for heating on Customer level 1 as shown:

1. Press the Menu button in the initial menu.

```

Main menu
Indoor temperature
settings      1
Return       Select
  
```

2. Press the Select button and scroll through the heating menus with the menu dial.

Move to the temperature settings for hot water on Customer level 1 as shown:

1. Turn the menu dial clockwise until the menu Adjusting the hot water settings is reached.

```

Main menu
Adjusting the hot
water settings  2
Return       Select
  
```

2. Press the Select button and scroll through the hot water menus with the menu dial.

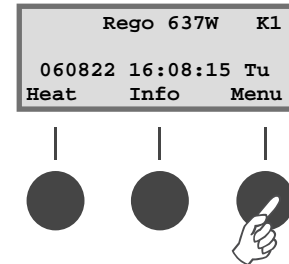

Note

Each menu is numbered in the lower right-hand corner; this indicates which main display it is associated to.

Read the temperatures on the heat pump

There are several different temperature sensors in the heat pump. Each sensor plays an important part in the heat pump's daily operations. Proceed as follows to read the temperatures on the heat pump:

1. Press the Menu button in the initial menu.
2. Turn the menu dial clockwise until the menu Monitor all temperatures (menu 3) is reached.

```

Main menu
Monitor all
temperatures  3
Return       Select
  
```

3. Press the Select button.
4. Turn the menu dial to scroll through all the heat pump's temperature sensors. See the next page.

All menus relating to temperature sensors

All menus relating to temperature sensors

All the menus associated with the heat pump temperature sensors are shown below. Note that the user cannot make any changes to the settings in these menus, only read the current values. Some menus are standard for all models while others are only available in combination with different accessories. The sensors give an alarm if the temperature is outside of the permitted range/values.



Note

All sensors are not included as standard on the heat pump, some are available as accessories for different application areas. See more information under respective menus.

Temperature readings
Return radiator GT1
Off 41,3° Now 40,3°
Return

The menu shows the return temperature in the heating system, i.e. the water from the radiators back to the heat pump. The temperature varies with the outdoor temperature.

Temperature readings
Out GT2
14,0°
Return

The menu shows the outdoor temperature. Some deviation compared to the true temperature may occur due to thermal radiation from the house to the installed outdoor sensor.

Temperature readings
Hot water GT3
Set 51,0° Now 50,0°
Return

The menu shows the set and present temperature in the lower section of the outer jacket of the hot water cylinder T4 (GT4). The temperature is approximately 5°C lower than the temperature of the domestic hot water inside the inner cylinder.

Temperature readings
Shunt, flow GT4
Tgt 40,3° Now 43,0°
Return

The menu is only applicable together with a flow sensor. If an extra curve with mixing valve is used, for example, for an underfloor heating system, you can see the temperature on the flow water in the circuit. The temperature varies with the outdoor temperature.

Temperature readings
Room GT5
Tgt 20,0° Now 19,5°
Return

The menu is only applicable together with a room sensor. The menu shows the set point value and present temperature in the room where the sensor is fitted.

Temperature readings
Compressor GT6
90,0°
Return

The menu shows the compressor's working temperature. The temperature varies between 70°C and 125°C during operations.

Temperature readings
Heat trfluid out GT8
45,0°
Return

The menu shows the flow temperature of the central heating water as it leaves the heat pump. It varies depending on the outdoor temperature and whether the heat pump is in domestic hot water (DHW) heating mode.

Temperature readings
Heat tr fluid in GT9
40,3°
Return

The menu shows the temperature of the return water that is fed into the heat pump. It varies depending on the outdoor temperature and whether the heat pump is in domestic hot water (DHW) heating mode. The heat pump stops at 57°C for safety reasons.

Temperature readings
Ht trfld(coll)inGT10
0,0°
Return

The menu shows the temperature of the heat transfer fluid that is fed into the heat pump from the collector system. It can vary between -5°C to +15°C during the year.

Temperature readings
Httrfld(coll)outGT11
-4,0°
Return

The menu shows the temperature of the heat transfer fluid that is fed out of the heat pump to the collector system. Normal operations should result in this being 1.5 - 5.0 degrees lower than the heat transfer fluid that is fed into the heat pump.

Extra functions (Customer level 2)

The section *Basic functions (Customer level 1)* contains the functions which are beneficial and commonly used.

However, there are numerous extra functions that can be used to control the heat pump. This can, for example, include activating the heat pump's holiday function or setting the time and date. If no settings are made on Customer level 2 (K2), the menu display will automatically return to Customer level 1 (K1) after 30 minutes. Proceed as follows to access the extra functions on Customer level 2:

1. Press and hold the Heat button until Access = CUSTOMER2 is displayed.
2. Press the Menu button to open the *Main menu*. From Customer level 2 access can be made to all Customer level 1 functions.

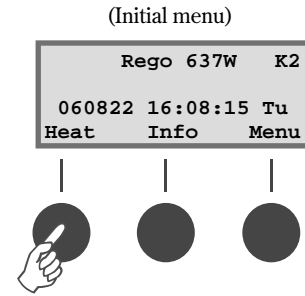

Press the Heat button until Access = CUSTOMER2 is displayed.

Menu outline for Extra functions (Customer level 2)

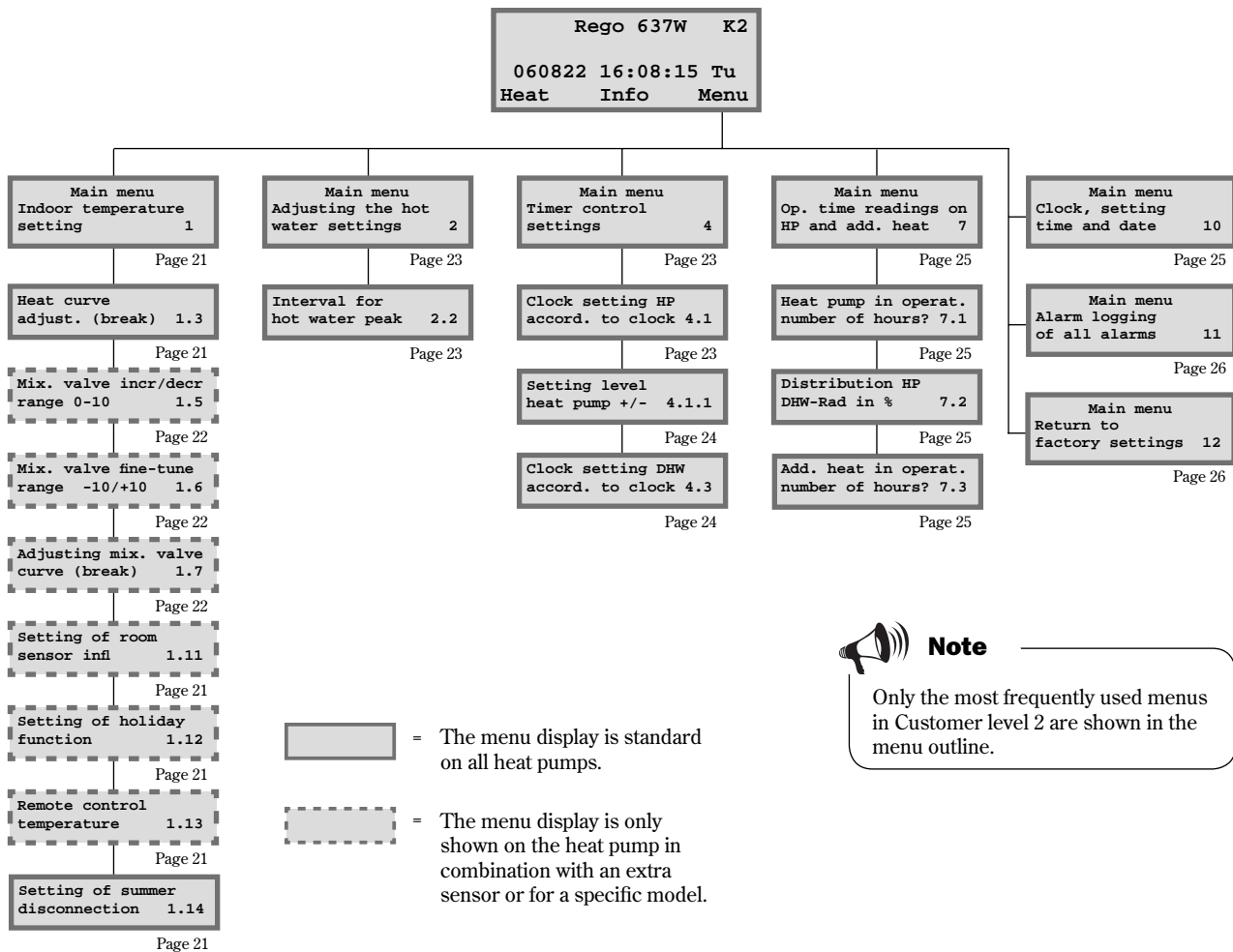

Note

Only the most frequently used menus in Customer level 2 are shown in the menu outline.

Temperature settings

Proceed as follows to access the temperature settings for the heating on Customer level 2:

1. Press and hold the Heat button until Access = CUSTOMER2 is displayed.
2. Press the Menu button.
3. Press the Select button and scroll through the menus using the menu dial.

```

Main menu
Indoor temperature
settings      1
Return       Select
    
```

Adapting the heat curve

The heat curve can be adjusted in increments of 5°C. For example, you can make a hump in the curve at 0°C. Navigate to menu 1.3, press Select and turn the menu dial until 0°C is displayed in the upper left part of the menu. Press Adjust and turn the dial to increase or decrease the return temperature. The change must not exceed 1 - 2°C. Press Save and wait at least 24 hours prior to any further adjustment. The purpose of breaking the curve is to be able to influence the heat pump's heat production at extra sensitive outdoor temperatures.

```

Temperature settings
Heat curve
adjust. (break) 1.3
Return          Select
    
```

Room sensor influence

The menu is only shown for heat pumps which have a room sensor installed. This menu is used to set how much the room sensor should influence the heat curve. A higher value will have a greater effect. The room sensor only fine-tunes the heat curve. Consequently, it is important that the basic setting of the heat curve's slope and fine-tuning are correct.

```

Temperature settings
Setting of room
sensor infl.    1.11
Return         Select
    
```

Holiday mode

The menu is only shown for heat pumps which have a room sensor installed. The holiday function gives the possibility to choose a number of days when the room temperature will be lowered to 15°C (the temperature is not adjustable). When the days have passed the heat pump returns to the normal heating setting. Hot water production is not affected by the holiday function.

```

Temperature settings
Setting of holiday
function        1.12
Return         Select
    
```

Remote control

The menu has no function.

```

Temperature settings
Remote control
temperature    1.13
Return        Select
    
```

Summer disconnection

This function disables the heating when the outdoor temperature rises above the set value.

```

Temperature settings
Setting of summer
disconnection  1.14
Return        Select
    
```

Set extra heat curve with mixing valve

If the system comprises underfloor heating combined with radiators, an extra heat curve with the mixing valve should be set. The menu is only displayed when there is an extra sensor, T4 (GT4), on the heat pump. Set the extra heat curve using two menus: Mix. valve incr/decr and Mix. valve fine-tune.

Increase or decrease the mixing valve

1. Press and hold the Heat button until Access = CUSTOMER2 is displayed.
2. Press the Heat button.
3. Turn the menu dial clockwise until the menu Mix. valve incr/decr is displayed.

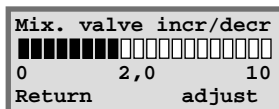

4. Press the Adjust button.
5. Turn the menu dial clockwise to choose a higher heat curve.
Turn the menu dial anti-clockwise to choose a lower heat curve.
6. Save the new value by pressing the Save button.



Note

The initial position of the floor heating circuit should be set to heat curve 2. The scale covers the range 0 to 10. Extra heat curve with mixing valve only works with an extra flow sensor T4 (GT4).

Fine-tune the mixing valve

1. Press and hold the Heat button until Access = CUSTOMER2 is displayed.
2. Press the Heat button.
3. Turn the menu dial clockwise until the menu Mix. valve fine-tune is displayed.

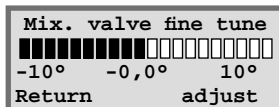

4. Press the Adjust button.
5. Turn the menu dial clockwise to set an upward, parallel offset on the curve.
Turn the menu dial anti-clockwise to set a downward parallel offset on the curve.
6. Save the new value by pressing the Save button.



Note

The example describes how to fine-tune the extra heat curve. The scale covers the range -10°C to +10°C.

Hot water settings

Hot water peak

This function takes the domestic hot water temperature temporarily up to approximately 65°C. Three settings are possible: inactive (default), daily or preferred day. The function is used to help protect the end user from potentially harmful bacteria, such as legionella.

```
Hot water setting
Interval for
hot water peak  2.2
Return          Select
```

Timer control

The menu for opening timer controls are as follows:

1. Press the Heat button until Access = CUSTOMER2 is displayed.
2. Press the Menu button.
3. Turn the menu dial clockwise until the menu Timer control settings (menu 4) is displayed.
4. Press the Select button and scroll through the menus using the menu dial.

```
Main menu
Indoor temperature
settings          1
Return          Select
```

```
Main menu
Timer control
settings          4
Return          Select
```

Setting of the heat pump according to clock

The function Clock setting HP accord. to clock is for those who want the heat pump to produce different amounts of heat at different times of the day and on different days of the week. This allows further energy savings. The room sensor T5 (GT5) influence is deactivated 2 hours after using clock setting for the heating, or after any type of external control of the heat pump. This allows the heating to return to ordinary settings.



Note

When there are time based tariffs with cheaper electricity for example during the night, any savings may be lost if the return to normal temperature occurs when the more expensive electricity price applies.

Example:

In the event that the heat pump is required to maintain the radiator temperature 3°C lower on Mondays between 22:00 and 06:00.

1. Turn the dial clockwise until the menu Clock setting HP accord. to clock (menu 4.1) is displayed.
2. Press the Select button.
3. Turn the menu dial clockwise to select the day. Now press the Adjust button to select the weekday with the symbol ^. Turn the menu dial clockwise one step to activate the start day. The weekday now has a capital letter.
4. Press the right-hand arrow (->) until the cursor reaches the first two zeros (00).

```
Clock setting
Clock setting HP
accord. to clock 4.1
Return          Select
```

```
Clock setting HP 1
mo      00:00-00:00
^
Return  adjust
```

```
Clock setting HP 1
Mo      00:00-00:00
^
Return  ->
```

```
Clock setting HP 1
Mo      00:00-00:00
^^
Return  ->
```

5. Turn the menu dial until the value 22:00 is displayed.
6. Press the right-hand arrow twice (->) to move the cursor two steps to the right.
7. Turn the menu dial until the value 06:00 is displayed.
8. Press the right-hand arrow so it is replaced by the Save function.
9. Finish by pressing the Save button.
10. Press the Return button.
11. Turn the menu dial clockwise until the menu Setting level heat pump +/- (menu 4.1.1) is displayed.
12. Press the Select button and set the temperature to -3°C, which is to apply for the chosen time intervals. Do not set a large temperature reduction, max approx. 3°C for radiator systems and max approx. 1.5°C for underfloor heating systems is sufficient.
13. Finish by pressing the Save button.

```
Clock setting HP 1
Mo      22:00-06:00
Return  <-    ->
```

```
Clock setting HP 1
Mo      22:00-06:00
                ^^
Return  <-    Save
```

```
Clock setting HP 1
Setting level
heat pump +/-  4.1.1
Return        Select
```



Note

To make the setting for every day of the week, carry out the instruction shown in the example seven times, once for each weekday.

The temperature set under 4.1.1 applies to all active time intervals.

Setting of the hot water according to clock

The Clock setting DHW accord. to clock (menu 4.3) works in exactly the same way as Clock setting HP accord. to clock (menu 4.1). This function can be used to completely disable hot water heating to save energy. This is particularly effective if peak tariffs are charged.

```
Clock setting
Clock setting DHW
accord. to clock 4.3
Return          Select
```

Reading operating times on the heat pump and electric heater

Statistics concerning the heat pump and additional electric heater operations are stored in the control unit. For example, the user can see how many hours the heat pump and the electric heater have been running. To view the operating times for the heat pump and electric heater:

1. Press and hold the Heat button until Access = CUSTOMER2 is displayed.
2. Press the Menu button.

```
Main menu
Indoor temperature
settings      1
Return        Select
```

3. Turn the menu dial clockwise until the menu Op. time readings on HP and add. heat (menu 7) is displayed.
4. Press the Select button and scroll through the menus using the menu dial.

```
Main menu
Op. time readings on
HP and add. heat 7
Return          Select
```

The number of hours the heat pump has been in operation

The menu shows the number of hours that the heat pump has been in operation since the day of installation.

```
Op. time readings
Heat pump in operat.
number of hours? 7.1
Return          Select
```

The heat pump's hot water mode and heating mode operations as a percentage

The menu shows the heat pump's allocation between hot water mode and heating mode. The allocation is stated as a percentage.

```
Op. time readings
Distribution HP
DHW-Rad in %    7.2
Return          Select
```

The number of hours the electric heater has been in operation

The menu shows the number of hours the electric heater has been in operation since the day of installation.

```
Op. time readings
Add. heat in operat.
number of hours? 7.3
Return          Select
```

Set the time and date

The heat pump has functions that are dependent on both the clock and date. Therefore, it is important that these are correct. This is how to access the menu Clock, setting time and date:

1. Press and hold the Heat button until Access = CUSTOMER2 is displayed.
2. Press the Menu button.
3. Turn the menu dial clockwise until the menu Clock, setting time and date (menu 10) is displayed.
4. Press the Select button and make your settings using the menu dial and menu buttons.

```
Main menu
Clock, setting
time and date 10
Return          Select
```

Alarms given by the heat pump

The menu provides information about the alarm type and when it occurred. If there is an asterisk (*) in the menu window this means the alarm is still active, i.e. the cause of the alarm remains. Access the Alarm logging of all alarms (menu 11) as follows:

1. Press and hold the Heat button until Access = CUSTOMER2 is displayed.
2. Press the Menu button.
3. Turn the menu dial clockwise until the menu Alarm logging of all alarms (menu 11) is displayed.
4. Press the Select button and scroll using the menu dial between any alarms that may have previously occurred. Alarms are stored in chronological order. Read more about the heat pump's alarms under the heading All alarms.

```

Main menu    K2
Indoor temperature
settings      1
Return       Select
  
```

```

Main menu
Alarm logging
of all alarms  11
Return       Select
  
```

Return to the heat pump's factory settings

To restore the factory settings on the heat pump, access the Return to factory settings menu (menu 12) as follows:

1. Press the Heat button until Access = CUSTOMER2 is displayed.
2. Press the Menu button.
3. Turn the menu dial clockwise until the menu Return to factory settings (menu 12) is displayed.
4. Press the Select button.
5. Return to the factory settings by pressing the Yes button. Returning to the factory settings will reset all user adjustments made on Customer levels 1 and 2, such as, temperature settings and time control settings.

```

Main menu    K2
Indoor temperature
settings      1
Return       Select
  
```

```

Main menu
Return to
factory settings 12
Return       Select
  
```

Part no: 8-716-113-341 Issue a
12167, Issue 1.0

EXCELLENCE COMES AS STANDARD

Worcester, Bosch Group
Cotswold Way, Warndon, Worcester WR4 9SW.
Tel. 01905 754624 Fax. 01905 754619
Worcester, Bosch Group is a brand name of BBT
Thermotechnology UK Ltd.
www.worcester-bosch.co.uk

CONTACT INFORMATION

WORCESTER, BOSCH GROUP:

TECHNICAL:	08705 266241
SERVICE:	08457 256206
SPARES:	01905 752571
LITERATURE:	01905 752556
TRAINING:	01905 752526
SALES:	01905 752640
WEBSITE:	www.worcester-bosch.co.uk

