

User instructions

Wall hung RSF gas fired condensing system boiler

Greenstar i System Compact ^{ErP}

For central heating systems and indirect mains fed domestic hot water



6720643358-00.1W0

These appliances are for use with :		
Natural Gas or L.P.G.		
(Cat. II 2H 3P type C13, C33 & C53)		
	Model	GC Number
Natural Gas	27i System Compact ^{ErP}	41-406-58
	30i System Compact ^{ErP}	41-406-60
L.P.G.	27i System Compact ^{ErP}	41-406-59
	30i System Compact ^{ErP}	41-406-61

If you smell gas:

- ▶ Well away from the building: call the National Gas Emergency Service on 0800 111 999.
- ▶ L.P.G. boilers: Call the supplier's number on the side of the gas tank.



Preface

Please read these instructions carefully

These instructions are applicable to the Worcester, Bosch Group appliance model stated on the front cover only.

These instructions apply in the UK/IE only and must be followed except for any statutory obligation.

After installation please leave this User instruction Manual, Installation, Commissioning and Servicing Instructions and completed Benchmark Checklist with the user.

Dedicated to heating comfort

Thank you for purchasing a Greenstar gas-fired condensing combination appliance manufactured by Worcester, Bosch Group. The company prides itself on manufacturing appliances to the strictest quality control standards throughout every stage of production.

Worcester, Bosch group has led the field in innovative appliance design and performance for over 50 years. This heritage means all our products are of exceptional quality and proven reliability.

The Greenstar range in particular is extremely energy efficient, offering you economical running costs and value for money. It is amongst the top energy rated appliances available.

There is also the reassurance of our parts and labour guarantee - backed up by Worcester Total Cover, an optional complete maintenance scheme to keep your appliance operating at peak condition and efficiency.

Contents

1 Key to symbols and safety instructions 4

- 1.1 Key to symbols 4
- 1.2 Safety precautions 4

2 General information 5

- 2.1 Energy efficiency 5
- 2.2 Servicing 5
- 2.3 Benchmark standard 5
- 2.4 User caution 5

3 Controls 6

- 3.1 Operating the boiler 8
 - 3.1.1 Boiler display 8
 - 3.1.2 Setting the boiler flow temperature for the system 8
 - 3.1.3 Turning the central heating off during the summer 8
 - 3.1.4 Boiler frost protection 9
 - 3.1.5 No Integral diverter valve fitted: Cylinder temperature adjustment 9
 - 3.1.6 Optional integral diverter valve kit fitted: Setting the cylinder hot water temperature. 9
 - 3.1.7 Domestic hot water eco and preheat modes 10
 - 3.1.8 Domestic hot water: switching between Eco and Preheat modes 10
 - 3.1.9 Turn off the Operation/fault diagnostic light (blue) 10

4 System Pressure 11

- 4.1 Sealed heating systems 11
- 4.2 External filling loop 12

5 Service Clearances 13

6 Maintaining your appliance 14

7 Fault Finding 15

- 7.1 Boiler alert state 16
- 7.2 Boiler reset 16
- 7.3 Extreme cold weather 17

8 Fault or Breakdown 18

9 Tips on energy saving 19

10 Environment / disposal 20

11 Your guarantee 20

12 Glossary 21

1 Key to symbols and safety instructions

1.1 Key to symbols

Warnings



Safety instructions in this document are framed and identified by a warning triangle which is printed on a grey background.

The following keywords are defined and can be used in this document:

- **NOTICE** indicates a situation that could result in damage to property or equipment.
- **CAUTION** indicates a situation that could result in minor to medium injury.
- **WARNING** indicates a situation that could result in severe injury or death.
- **DANGER** indicates a situation that will result in severe injury or death.

Important information



This symbol indicates important information where there is no risk to people or property.

Additional symbols

Symbol	Meaning
1.	a numbered step in an action sequence
▶	a step in an action sequence
→	a reference to a related part in the document or to other related documents
①	a reference number to identify or refer to a part or item
•	a list entry
-	a list entry (second level)

Table 1

Examples of additional symbols used

A numbered step in an action sequence

A sequence of numbered steps or actions carried out in a specific order to complete a task.

1. First action
 2. Second action
 3. Third action
- etc.

A step in an action sequence

A sequence of defined actions or steps carried out in order to complete a task.

- ▶ Action
- ▶ Next action
- ▶ etc

A reference to a related part in the document or to other related documents.

To refer the reader to a specific figure/table/section within the manual.

→ e.g. figure 1.

A reference number to identify or refer to a part or item.

In a related figure, items or parts identified by a sequential number.

List entries, first and second levels

- A single component/item
- A component/list, made up of multiple parts/items.
 - Sub component or sublist of main component/list.
 - etc.

1.2 Safety precautions

If you smell gas:

A gas leak could potentially cause an explosion. If you smell gas, observe the following rules.

- ▶ Prevent flames or sparks:
 - Do not smoke, use a lighter or strike matches.
 - Do not operate any electrical switches or unplug any equipment.
 - Do not use the telephone or ring doorbells.
- ▶ Turn off the gas at the meter or regulator.
- ▶ Open windows and doors.
- ▶ Warn your neighbours and leave the building.
- ▶ Prevent anyone from entering the building.
- ▶ Well away from the building: call the National Gas Emergency Service on 0800 111 999.
- ▶ L.P.G. boilers: Call the supplier's number on the side of the gas tank.

Appliance operation:

This appliance can be used by children aged from 8 years and above and persons with reduced physical, sensory or mental capabilities or lack of experience and knowledge, if they have been given supervision or instruction concerning the use of the appliance, in a safe way, and understand the hazards involved.

Children shall not play with the appliance.

Cleaning and user maintenance shall not be made by children without supervision.

Combustible and corrosive materials:

Chemically aggressive substances can corrode the appliance and invalidate any guarantee.

- Do not store or use any combustible materials (paper, thinners, paints, propellants, cleaning agents etc.) inside the cupboard containing the appliance or within the vicinity of the appliance.

Fittings and modifications:

Only a competent engineer can remove the appliance case and carry out any work, in accordance with the Gas Safety (Installation and Use) Regulations.

- Do not remove the appliance case.

Any misuse or unauthorised modifications to the appliance, flue or associated accessories and heating system will invalidate the guarantee.

- Do not modify the appliance or flue system in any way.

Worcester, Bosch Group accepts no liability arising from any such actions. This does not affect your statutory rights.

Cleaning the appliance case:

Use a damp, soft cloth to clean the outer painted metal case of the appliance, do not use chemicals or abrasive materials.

2 General information

2.1 Energy efficiency

Energy efficiency information is given in the Installation, Commissioning and Servicing Instructions supplied with the appliance.

2.2 Servicing



Ensure that the service engineer completes the Service Record in the Benchmark Checklist after each service. The Benchmark Checklist and service interval record can be found at the rear of the Installation, Commissioning and Servicing Instructions.

- The appliance must be serviced regularly by a competent, qualified person, such as a Worcester service engineer or other Gas Safe registered engineer.
- Always use original spares, to help maintain the efficiency, safety and reliability of the appliance and have the Service Record completed in the Benchmark Checklist.

The completed Benchmark Checklist will be required in the event of any guarantee work and may be required by the local Building Control Inspector.

2.3 Benchmark standard



The Benchmark initiative is a code of practice to encourage the correct installation, commissioning and servicing of domestic central heating appliances and system equipment.

A “checklist” is dispatched with every appliance and can be found towards the back of the Installation, Commissioning and Servicing Instructions. This is a vital document that needs to be completed by the installer at the time of installation. It confirms that the appliance has been installed and commissioned according to the manufacturer's instructions.

The service record provides space for the recording of regular servicing of the appliance/heating system and this can become a valuable document when, for example, you wish to sell the property. The service record will show a potential purchaser that the heating system has received regular professional maintenance and servicing during its lifetime.

The Benchmark initiative aims to:

- Raise standards among professional installers
- Build and maintain high safety standards in the industry
- Improve customer satisfaction levels
- Make a contribution to the nation's commitment to climate change

2.4 User caution

- It is forbidden for any interference with the appliance other than those actions allowed in this document.



CAUTION: Incorrect use

- ▶ Any incorrect use can result in danger to the householder.

3 Controls

► To gain access to the boiler controls pull the flap down using the curved flap handle.

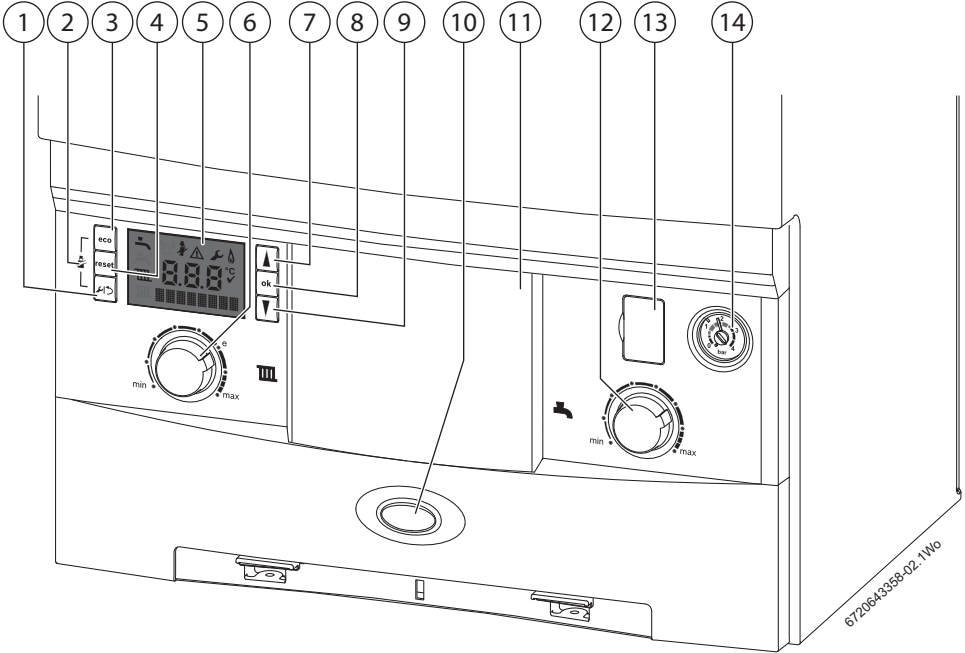
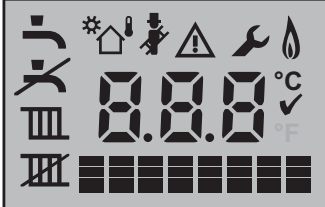













Fig. 1 Basic boiler controls

Boiler Controls	1	Service menu/back button	9	Scroll down button
	2	Service engineer symbol = boiler is set to maximum or minimum output for service	10	The blue light is ON when the boiler is in an operational mode. It will also flash to indicate a fault.
	3	Eco button*	11	Position for optional programmer
	4	Reset button	12	Hot water temperature control*
	5	Boiler display	13	Diagnostic port**
	6	Central heating temperature control	14	Central heating system pressure gauge
	7	Scroll up button		
	8	OK - Select/confirmation button		
* Requires optional integral diverter kit to be functional		** for Worcester service engineer use only		

Display symbols

SCREEN DISPLAY	BRIEF DESCRIPTION	EXPLANATION
	All possible screen symbols	This screen is displayed briefly during boiler start up and shows all the symbols that could be displayed on the screen.
	Numerical display	Displays a temperature setting or boiler status code.
	Text display	Display PreHeat or Eco, or the Alert code
	Hot water	Displays this symbol during a DHW demand, if the optional integral diverter valve kit is fitted.
	Central Heating	Displays this symbol during central heating demand.
	Service engineer mode	Displays during service when the boiler is set to maximum or minimum output.
	Alert	Displays along with the boiler status code and diagnostic code during a fault condition.
	Service mode	Displays when a qualified service engineer is in the service menus.
	Burner on	The boiler is in operation and the flame is alight.
	Centigrade indication	Displays next to the temperature reading.
	Confirmation	This symbol confirms a manual change.
	Maintenance codes	A code displayed with an H and a number relates to a maintenance issue. This is not a boiler fault but an indication that something will need attention concerning the boiler. The example shown is H13 Service interval reached, the boiler requires servicing. Call your installer or Worcester Bosch Group to organise a service visit.

3.1 Operating the boiler

3.1.1 Boiler display

This is typical of the display when the boiler is not supplying a heat demand. The display will not be backlit and the internal temperature of the boiler is indicated.

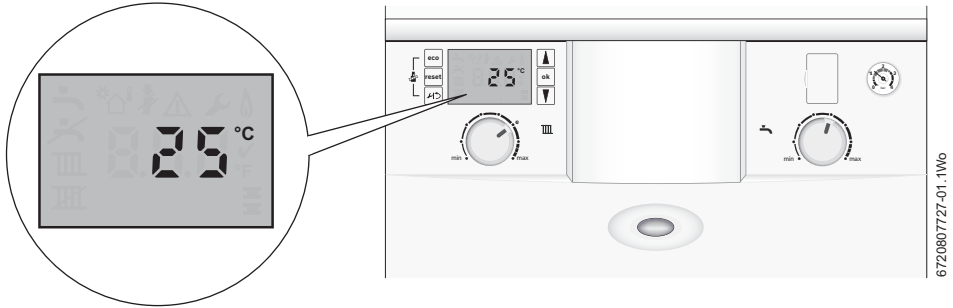

3.1.2 Setting the boiler flow temperature for the system

1. Turn the central heating temperature control knob to the desired flow temperature between 30 and 82°C, this will be indicated on the digital display. This is not the room temperature but the flow temperature through the system. The "e" point provides guidance for the maximum temperature setting for optimum energy efficiency.
2. The radiator symbol will be displayed to confirm that the a heating setting is being changed.
3. The value is displayed during this process, press to exit or after five seconds of inactivity the boiler display will return to the default screen.

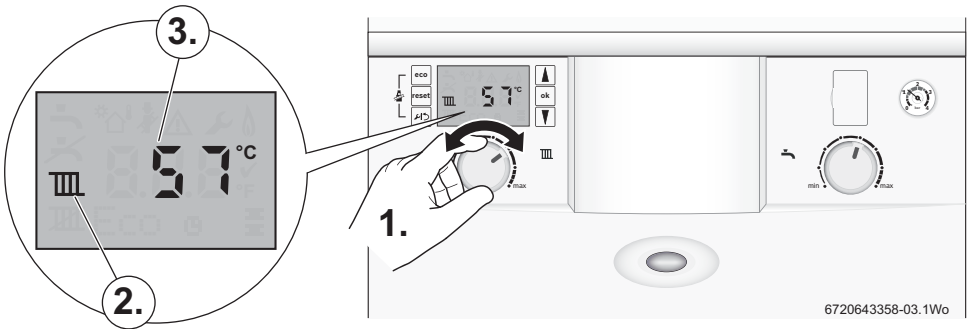

- Comfort levels within rooms should be controlled by your thermostatic radiator valves and/or room thermostat.

3.1.3 Turning the central heating off during the summer



Do not switch the appliance off at the mains fused spur.

- Turn your programmer/timer to the off position.
- Please refer to the programmer/timer manufacturer's instructions.

3.1.4 Boiler frost protection



NOTICE: The boiler must be switched on with a gas supply in order for the built-in auto frost protection to work as described.

If you are leaving your property unoccupied during cold weather, please leave your programmer on constant and your room thermostat set to 15°C.

- ▶ If the temperature within the boiler falls below 8°C the pump will run to circulate water and prevent the system freezing.
 - If the temperature does not rise to 9°C within 30 minutes of the pump operating, the boiler will fire up to provide heat to bring the temperature up.
- ▶ If the temperature within the boiler falls below 5°C the boiler will fire immediately, bringing the boiler temperature up to 15°C to avoid the possibility of the system freezing.
- ▶ This process will be repeated until such time that the boiler temperature does not drop below 5°C.

3.1.5 No Integral diverter valve fitted: Cylinder temperature adjustment

If a heat demand occurs, the radiator and flame symbols will be displayed

If the domestic hot water control is adjusted or the “eco” button is pressed:

- ▶ N/A is displayed briefly.
- ▶ This function will not affect the cylinder hot water temperature.

To adjust the water temperature of the cylinder:

- ▶ Adjust the cylinder temperature thermostat on the cylinder.

3.1.6 Optional integral diverter valve kit fitted: Setting the cylinder hot water temperature.



An internal or external timer/programmer coupled with the optional integral diverter valve kit with cylinder temperature sensor is required to be able to set the hot water temperature.

If an FR110, FW100 and Sense II controller is also fitted, in conjunction with the diverter valve, they assume control over the delivered temperatures, reducing the effect of the temperature controls. Set both to maximum.

1. Turn the hot water temperature control knob to the desired level between 40 and 70°C, this will be shown on the digital display.

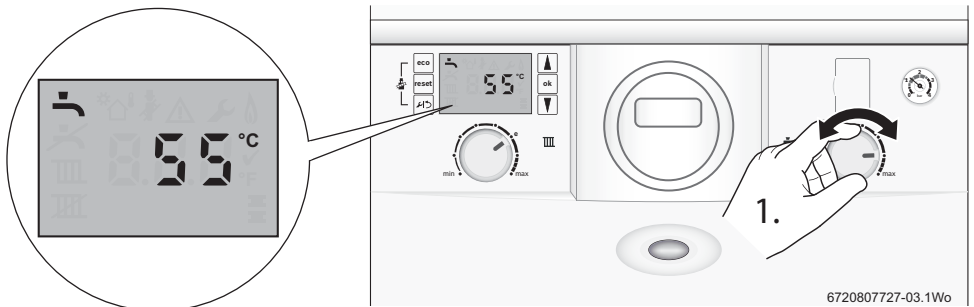

Fig. 2 Hot water temperature

- ▶ The tap symbol will be displayed to confirm that the hot water is being adjusted.
- ▶ After five seconds the boiler display will return to the default screen.



An external timer may be fitted instead of an internal timer.

3.1.7 Domestic hot water eco and preheat modes

- Eco mode is an energy saving feature which disables the Preheat function:
 - Eco is enabled by default, during the initial appliance start up and “Eco” [2] will be displayed to confirm this state.
 - During the ON periods [1] set by the time control, Eco mode will use less energy, because the boiler will maintain a slightly lower average temperature.
- Preheat mode, the appliance heats the cylinder more frequently. This tops up the cylinder temperature for quicker heat up times, this is useful for large/longer demand periods during the hot water ON periods, “PreHeat” [3] will be displayed to confirm this state.
 - During the ON periods [1] set by the time control, the cylinder is heated more regularly to reduce the time taken to deliver hot water.



6720813281-01.1Wo

3.1.8 Domestic hot water: switching between Eco and Preheat modes

1. Press and hold the Eco button for at least four seconds to enter the energy saving Eco mode, when Eco mode is active, “Eco” will be displayed.
To exit Eco mode and return to PreHeat
2. Press and hold the Eco button for at least four seconds and “PreHeat” will be displayed.

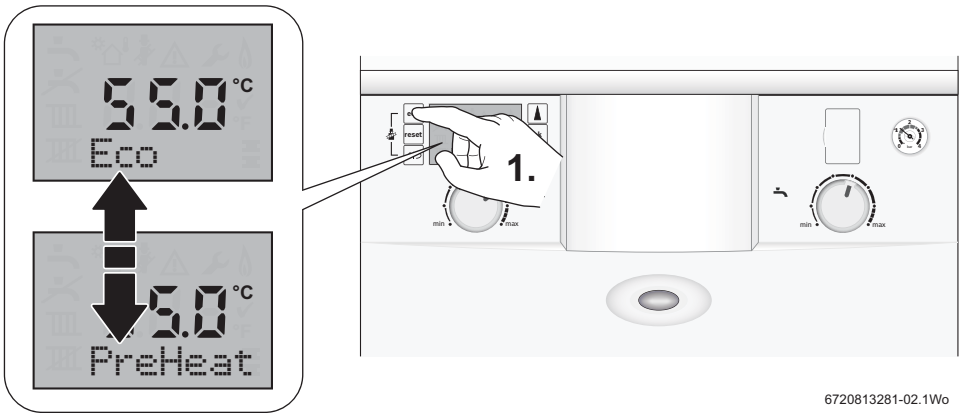

6720813281-02.1Wo

Fig. 3 Switching between Eco & Preheat mode

3.1.9 Turn off the Operation/fault diagnostic light (blue)

You may choose to deactivate the operation/fault diagnostic light. Please ask your installer to set-up this feature.

The light will still flash to alert you to a possible fault, but will not activate during a heat requirement demand for heating or hot water.

4 System Pressure

4.1 Sealed heating systems

This appliance is fitted to a sealed heating system which is pre-pressurised. Your installer will advise you of the minimum and maximum pressure indicated on the pressure gauge.

- ▶ Check regularly that the pressure is maintained.
- ▶ If the pressure gauge reads less than 1 bar then the system requires re-charging.
- ▶ Contact your installer or maintenance engineer if a permanent significant decrease or increase in pressure is indicated on the pressure gauge.

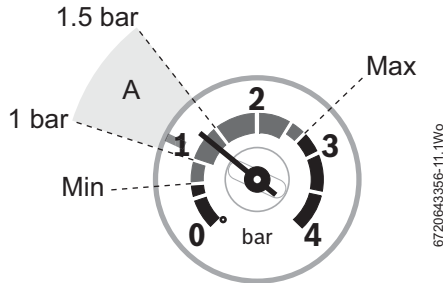

Fig. 4 Optimum system pressure when your boiler is cold (area A)

- ▶ Use the external filling loop to re-pressurise your boiler, refer to the following section 4.2.



NOTICE: To comply with the Water Authority regulations you must remove the “filling key” or disconnect the external filling loop after re-pressurisation.

4.2 External filling loop



NOTICE: External filling loops

- ▶ If the filling loop does not look like the one shown in the figure below or you cannot find your filling loop, contact your installer.
- ▶ To comply with Water Authority regulations you must disconnect the external filling loop after re-pressurisation.

Once the external filling loop has been located, follow the instructions for re-pressurising the system.

1. Unscrew blanking cap.
2. Attach the hose to the valves, screw on hand-tight.
3. Turn the handle/screwdriver slot through 90° to open the valves.
4. The handle/screwdriver slot will be in-line with the valves

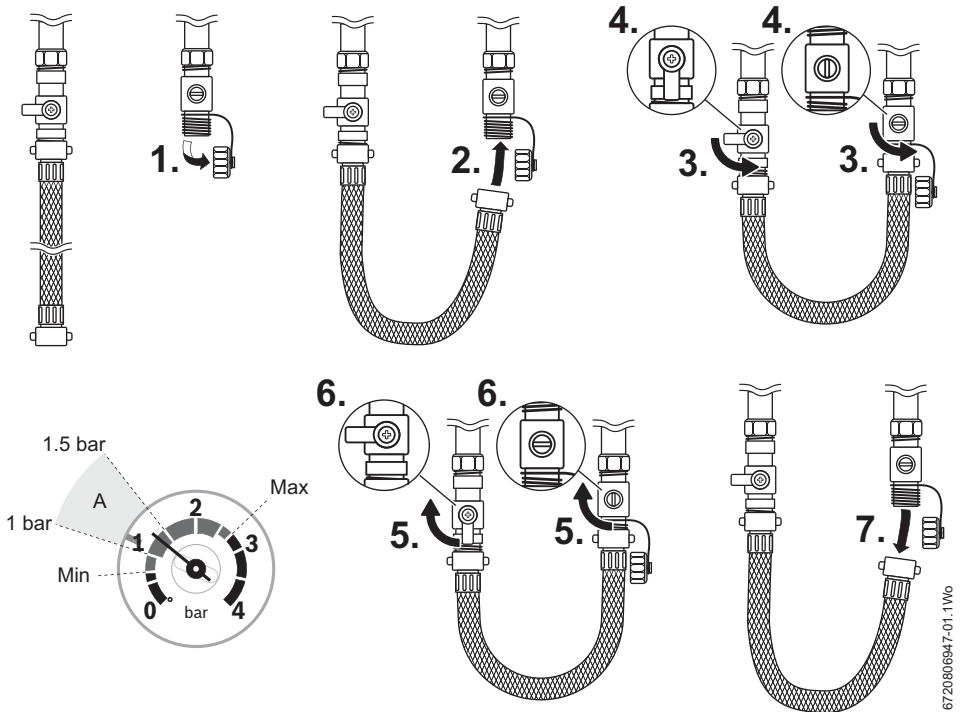

Fig. 5 External filling loop

5. When the pressure reaches between the 1 and 1.5 bar marks (zone A), turn the handle/screwdriver slot back, through 90°, to close the valve.
6. The handle/screwdriver slot will be at 90° to the valves
7. Remove the hose and replace the blanking caps.



If the pressure gauge reads more than 1.5 bar as a result of over filling, bleed one radiator until the pressure gauge returns to between 1 and 1.5 bar.

5 Service Clearances

Your installer will have provided adequate space around the boiler for safety and servicing access.



CAUTION: Restricted space.
The boiler may overheat.

- ▶ Do not restrict this space with the addition of cupboards, shelves etc. next to the boiler.



NOTICE: Combustible and corrosive materials:
Chemically aggressive substances can corrode the appliance and invalidate any guarantee.

- ▶ Do not store or use any combustible materials (paper, thinners, paints, propellants, cleaning agents etc.) inside the cupboard containing the appliance or within the vicinity of the appliance.

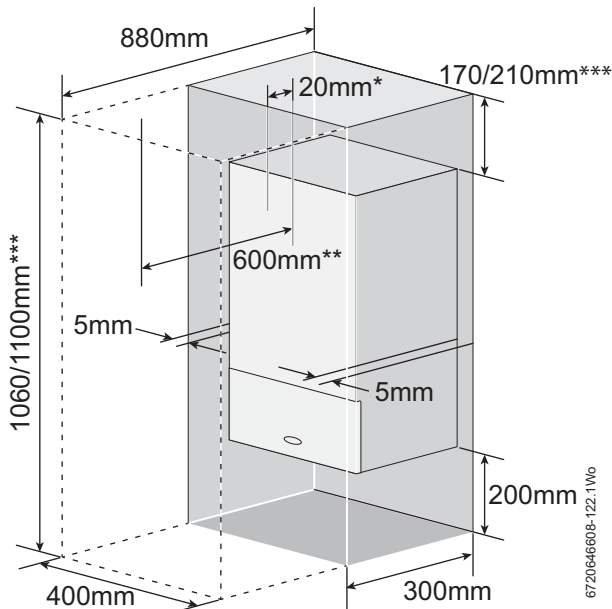

Fig. 6 Service clearances

- [*] Minimum clearances to removable door
- [**] Minimum clearances required for servicing
- [***] Height for either 60/100 flue or 80/125 flue

6 Maintaining your appliance

Your new gas-fired appliance represents a long term investment in a reliable, high quality product.

Wipe the appliance casing with a soft clean cloth. Please do not use chemical cleaning products which may damage the paint finish.

In order to realise its maximum working life, and to ensure it continues to operate at peak efficiency and performance, it is essential that your appliance receives regular servicing and maintenance checks from a competent person beyond the initial guarantee period.

If your Greenstar gas-fired appliance should fail to operate correctly or requires servicing, please contact the Worcester, Bosch Group Appointments Team (see rear cover for details).

Details of the appliance including the Gas Council number can be found on the front cover of these User Instructions and on the appliance identification label on the appliance fascia.

The Gas Council number is also listed on the front cover of your Installation, Commissioning and Servicing Instructions.

7 Fault Finding

In the event that the appliance stops functioning or does not perform as expected, please see table below. These problems are some of the most common causes. Should the problem persist or if other fault codes are displayed, then it will be necessary to contact Worcester, Bosch Group.

This table gives information on basic operating system problems.

Problem	Cause	Remedy
EA fault code flashing on display	No gas supply/low gas supply pressure	▶ Contact your gas supplier.
	Condensate outlet blocked	▶ If it is safe to do so, check your condensate pipe outlet for blockages, such as ice or foreign objects.
	Flue blocked	▶ If it is safe to do so, check your flue outlet for damage or blockages.
Desired room temperature is not reached	Thermostatic radiator valve(s) set too low	▶ Increase thermostatic radiator valve setting(s).
	Temperature control for central heating flow on appliance set too low	▶ Increase central heating flow temperature control setting
	Low temperature setting on the room thermostat	▶ Increase setting on the room thermostat.
	Air trapped in heating system	▶ Bleed radiators and re-pressurise the heating system
	Low system water pressure	▶ Re-pressurise the system, refer to page 12
Desired room temperature too high	Thermostatic radiator valves are set to high	▶ Turn down thermostatic radiator valves.
	Room thermostat is set too high	▶ Turn down room thermostat.
Radiators are too hot	Temperature control on appliance set too high	▶ Reduce central heating temperature by turning down the Central Heating control on appliance. Note: This could prevent your property reaching the desired temperature during cold weather periods.
Heating stays on for too long	Clock is incorrectly set	▶ Check clock setting and adjust
No blue Operation/Fault Indicator	Momentary power failure	▶ Disconnect boiler supply, wait a few seconds then reconnect.
	Energy saving feature is activated	▶ Ask your installer to reset the blue light
Hot water temperature too low	Temperature set too low: • Cylinder thermostat control. • Appliance hot water control (this feature is only available if the option integral diverter valve has been fitted)	▶ Check setting and adjust
	Air trapped in heating system	▶ Bleed radiators and re-pressurise the heating system
	Low system water pressure	▶ Re-pressurise the system, refer to page 12
Hot water temperature too high	Temperature set too high: • Cylinder thermostat control. • Appliance hot water control (this feature is only available if the option integral diverter valve has been fitted)	▶ Check setting and adjust



Table 2 Fault finding

7.1 Boiler alert state

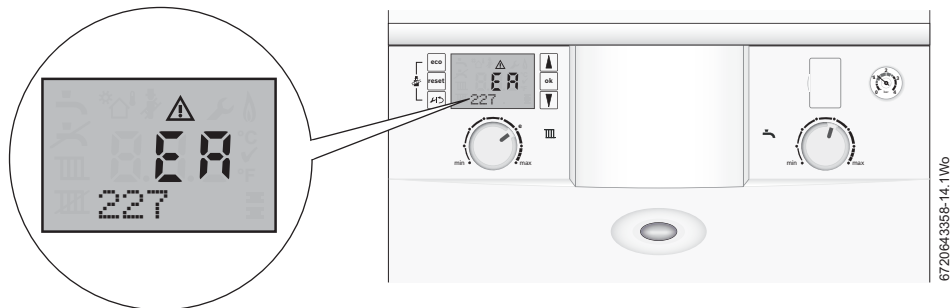
In the event of an alert, a fault code and an alert symbol  will be displayed on the boiler display, and the blue operation/fault light will flash, e.g. EA, reset your boiler.



7.2 Boiler reset

1. To reset the boiler, press .
 2. "Reset" and  are briefly displayed.
- ▶ If the reset was successful the boiler will return to normal operation.
 - ▶ If the reset was not successful then the alert code will be displayed again, and the blue operation/fault light will continue to flash.

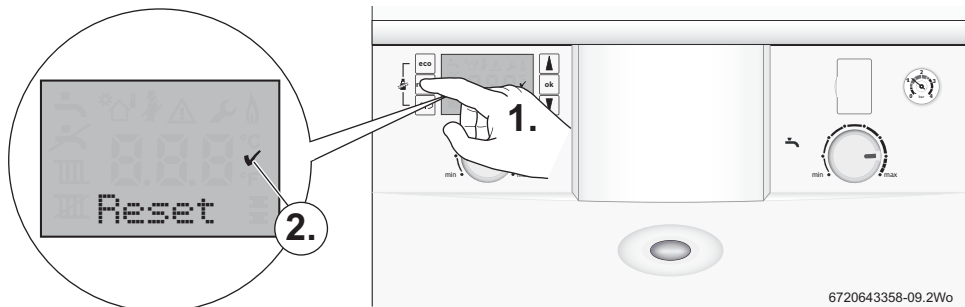

Due to the internal safety systems of your Greenstar CDi Compact boiler, some codes cannot be cleared by a simple reset. Please contact Worcester, Bosch Group for further assistance.

When calling Worcester, Bosch Group about a fault, it will be useful to quote the alert code and three digit number under the alert code, e.g. EA and 227. If there is a fault that cannot be reset by you, the user, then a service engineer visit will be necessary.

7.3 Extreme cold weather

In certain instances where the condensate pipe work is run externally or in an unheated area, such as a garage, the condensate pipe work can be at risk of freezing, even if well insulated.

A frozen/blocked condensate pipe will cause the boiler to shut down. Worcester, Bosch Group have available on our website helpful videos in the Customer service section.



WARNING: Falling hazard!

Failure to follow this guidance may result in personal injury.

- ▶ Only attempt to thaw a condense pipe that is at ground level and easily accessible.
- ▶ Never attempt to thaw a condense pipe that is at height.



CAUTION: Pipe damage

- ▶ **DO NOT** use boiling water to thaw the condensate pipe!

If the condensate pipe has frozen:

- ▶ Locate the blockage.
It is likely that the pipe is frozen at the most exposed point outside the building or where there is an obstruction to flow. This could be the open end of the pipe, at a bend or elbow, or where there is a sag in the pipe in which condensate can collect. The location of the blockage should be identified as closely as possible before taking further action.
- ▶ Thaw the frozen pipe.
The pipe can be thawed by applying a hot water bottle, a microwaveable heating pack (the sort used for muscular aches and pains) or a cloth soaked in hot water to the exterior of the pipe, close to the point of blockage. Hot water, but not boiling, can also be poured onto the pipe from a watering can or similar container. Care must be taken at pedestrian areas where this water may freeze and create a slip hazard.
- ▶ Worcester, Bosch Group have available on our website helpful videos in the Customer service section to aid in thawing a frozen pipe.
- ▶ Once the pipe has been thawed the boiler must be reset, press the reset button for five seconds and wait two to three minutes for the boiler to restart.
- ▶ If the boiler does not restart, contact Worcester, Bosch Group Appointments Team on: 0330 123 9339.
- ▶ Contact your installer in order to find a permanent solution to the problem.

8 Fault or Breakdown

This boiler is supported in the UK and Eire by Worcester, Bosch Group.

Specialist Service Engineers are available to attend a breakdown occurring on this boiler.



Invoices for attendance and repair work carried out on this boiler by any third party will not be accepted.

-
- No charge will be made for parts and/or labour providing:
A boiler fault is found and the appliance has been installed within the last 24 months. Reasonable evidence of this must be supplied on request. i.e. the Benchmark Checklist.
 - A call-out charge will be made where:
 - The boiler has been installed for over 24 months.
 - Evidence cannot be provided that the first year service inspection has been carried out (i.e. an entry in the Benchmark Checklist).
 - Our Field Service Engineer finds no fault with the boiler.
 - The cause of breakdown is misuse or with other parts of your plumbing/heating system, or with equipment not supplied by Worcester, Bosch Group.

Technical Support



No boiler fault is found on over 30% of all service calls.

In the case of a suspected fault, refer to the fault finding section of this guide.

In the event of a boiler fault or breakdown please contact Worcester, Bosch Group appointments team on 0330 123 9339. Your advisor will arrange for an engineer to call with the minimum of delay; under normal circumstances this will be from 1 - 3 working days (excluding weekends) for priority breakdown situations (no hot water and/or heating).

9 Tips on energy saving

Heating economically

The appliance provides a high level of comfort whilst keeping gas consumption low and so minimising the environmental impact.

The gas supply to the appliance's burner is regulated according to the demand for heat. The appliance operates with a low flame if the demand for heat reduces. The technical term for this process is modulating control.

Modulating control reduces temperature fluctuations and provides an even distribution of heat throughout the home. This means that the appliance may stay on for relatively long periods of time but will use less gas than a appliance that continually switches on and off.

Central heating systems with room thermostat/thermostatic radiator valves

With modern heating systems designed around a 20 °C heat loss across the system, the optimum setting for a condensing appliance as described on section 3.1.2, Setting the boiler flow temperature for the system. The system must be balanced correctly and the radiators may need upgrading.

The temperature of each room can be set individually (except primary room with the room thermostat) using the thermostatic radiator valves.

Room thermostats

Reducing the setting of the room thermostat by 1 °C can reduce fuel consumption by up to 10%.

New control systems

Upgrade your heating control system if necessary with the latest equipment available.

Roof insulation

Around 30% of the heat loss from a property is through the roof. Replace any old insulation with new insulation, preferably of around 200mm thickness or more.

Window frames

Single glazed windows, particularly those with steel frames, can lose a great deal of heat. Consideration should be given to replacement with PVCu or wooden framed double glazed units.

Radiators

If a radiator is sited underneath a window, its performance will be affected if the curtains are allowed to drape over the radiator. Shelves fitted above or in front of the radiator should also be avoided.

It is advisable to manually adjust all thermostatic radiator valves every 2 - 3 months to prevent them sticking. Ensure radiator valves are correctly set and not damaged.

Draughts

Try to ensure that draughts around doors, windows, letter boxes and keyholes etc. are reduced by using a suitable draught excluder.



WARNING: Air vents

- ▶ Do not block or seal any air vents that are installed to ensure that the central heating appliance operates safely.

Curtains

Lined curtains, or heavier full length curtains can provide excellent insulation. However, always ensure that the curtains do not drape over radiators.

10 Environment / disposal

Environmental protection is a fundamental corporate strategy of the Bosch Group. The quality of our products, their economy and environmental safety are all of equal importance to us and all environmental protection legislation and regulations are strictly observed. We use the best possible technology and materials for protecting the environment taking account of economic considerations.

Packaging

We participate in the recycling programmes of the countries in which our products are sold to ensure optimum recycling. All of our packaging materials are environmentally compatible and can be recycled.



USED APPLIANCES

- ▶ All Greenstar gas boilers are 100% recyclable. The various assemblies can be easily dismantled and synthetic materials are marked accordingly. Assemblies can therefore be sorted by composition and passed on for recycling.

11 Your guarantee

This boiler has a guarantee against faulty materials or workmanship for a period from the date of installation subject to the following terms and conditions:

- During the period of this guarantee any components of the boiler which are proven to be faulty or defective in manufacture will be exchanged or repaired free of charge by Bosch Thermotechnology Ltd.
- The householder may be asked to prove the date of installation, that the boiler was correctly commissioned and, where appropriate, the first year's service has been carried out to the satisfaction of Bosch Thermotechnology Ltd., when requested. These should be documented as a part of the Benchmark Checklist.
- The boiler has been used only for the normal domestic purposes for which it was designed.

This guarantee does not affect your statutory rights.

Guarantee registration

Your Greenstar boiler carries a guarantee against faulty material or manufacturer subject to Terms and Conditions. To read the full Terms & Conditions please visit us on-line at www.worcester-bosch.co.uk/guarantee. The Guarantee Registration form is available on this same page and can be completed and submitted electronically. Alternatively, please telephone one of our Guarantee Registration advisors on 0330 123 2552. Your statutory rights are not affected by the manufacturers guarantee.

For your own record:

Please ensure that the Benchmark Checklist has been completed by your installer or service engineer.

Model	
Serial No. ¹⁾	
Type/size	
Date of installation	
Name of Installer	
Telephone number of Installer	

Table 3

1) See boiler identification label on boiler fascia or Benchmark Checklist in the back of the Installation, Commissioning & Servicing Instructions.

12 Glossary

Central heating systems

All radiators must be heated at an even rate. If the top of a radiator is at a lower temperature than the bottom then it should be bled by releasing air through the bleed screw at the top of the radiator.

Ask your installer to show you how this is done.

This boiler is fitted to a sealed system. Should water leaks be found or if excessive bleeding is required, then a service engineer must be contacted to inspect the installation and rectify any fault.

Only additives that are compatible with aluminium may be used in the system. Any incompatible additive used will invalidate the guarantee.

Plumbing and condensate drain

This is a condensing boiler and the flue terminal will, at times give out a plume of water vapour. This is quite normal.

The boiler produces condensate which is discharged regularly by a syphon within the boiler via a plastic pipe to a drain. This pipe must not be blocked or altered in any way.

Room thermostat / programmer

A room thermostat / programmer must be fitted to control the central heating. This controls the times and temperatures of the central heating, preventing the boiler from firing unnecessarily. Refer to the instructions supplied with the thermostat and programmer for further information.

Thermostatic radiator valves

Thermostatic radiator valves must be fitted in sleeping accommodation. It is recommended that this type of valve is fitted to all but one of the radiators. The remaining radiator, where the room thermostat is located, must be uncontrolled and left open.

Pump over run function

After the boiler has finished a demand for central heating or hot water, the pump may continue to run for a short while to dissipate the heat from within the boiler.

Pump anti-seizure

If there has been no heating demand for 24 hours, the boiler will run the system pump for a few seconds to reduce the possibility of pump seizure during long periods of inactivity.

Notes

Worcester, Bosch Group
Cotswold Way, Warndon, Worcester WR4 9SW.
Tel. 0330 123 9559
Worcester, Bosch Group is a brand name of
Bosch Thermotechnology Ltd.

worcester-bosch.co.uk

6 720 813 281 (2014/09)

WORCESTER, BOSCH GROUP:

TECHNICAL SUPPORT:	0330 123 3366
APPOINTMENTS:	0330 123 9339
SPARES:	0330 123 9779
LITERATURE:	0330 123 9119
TRAINING:	0330 123 0166
SALES:	0330 123 9669



WORCESTER
Bosch Group