

# USER INSTRUCTIONS

WALL HUNG RSF GAS FIRED CONDENSING COMBINATION BOILER

## GREENSTAR 24/28/30

FOR SEALED CENTRAL HEATING SYSTEMS AND MAINS FED  
DOMESTIC HOT WATER



6720801019-00.1Wo



  
**WORCESTER**  
Bosch Group

## **PREFACE**

### **PLEASE READ THESE INSTRUCTIONS CAREFULLY**

These instructions are applicable to the Worcester, Bosch Group boiler model stated on the front cover only.

These instructions apply in the UK/IE only and must be followed except for any statutory obligation.

After installation please leave this User instruction Manual, Installation, Commissioning and Servicing Instructions and completed Benchmark Checklist with the user.

### **DEDICATED TO HEATING COMFORT**

Thank you for purchasing a Greenstar gas-fired condensing combination boiler manufactured by Worcester, Bosch Group. The company prides itself on manufacturing boilers to the strictest quality control standards throughout every stage of production.

Worcester, Bosch group has led the field in innovative boiler design and performance for over 50 years. This heritage means all our products are of exceptional quality and proven reliability.

The Greenstar range in particular is extremely energy efficient, offering you economical running costs and value for money. It sits in SEDBUK Band A, and is therefore amongst the top energy rated boilers available.

There is also the reassurance of our no-nonsense 2 years parts and labour guarantee - backed up by Worcester Total Cover, an optional complete maintenance scheme to keep your boiler operating at peak condition and efficiency.

---

**CONTENTS**

---

<b>1</b>	<b>Symbols and safety precautions</b> .....	<b>5</b>
1.1	Explanation of symbols .....	5
1.2	Safety precautions .....	6

---

<b>2</b>	<b>General information</b> .....	<b>7</b>
----------	----------------------------------	----------

---

<b>3</b>	<b>Opening the control panel cover</b> .....	<b>8</b>
----------	--	----------

---

<b>4</b>	<b>Overview of controls</b> .....	<b>9</b>
----------	-----------------------------------	----------

---

<b>5</b>	<b>Operation</b> .....	<b>10</b>
5.1	Switching the appliance on/off .....	10
5.2	Switching on the central heating .....	11
5.3	System controls .....	12
5.4	Setting hot water temperature .....	13
5.5	Frost protection .....	15
5.6	Button lock .....	16
5.7	Boiler reset .....	17
5.8	Display codes .....	18
5.9	Extreme cold weather .....	19

---

<b>6</b>	<b>System Pressure</b> .....	<b>20</b>
6.1	Sealed heating systems .....	20
6.2	External filling loop .....	21

---

<b>7</b>	<b>Fault or Breakdown</b> .....	<b>23</b>
----------	---------------------------------	-----------

---

<b>8</b>	<b>Environment / disposal</b> .....	<b>24</b>
----------	-------------------------------------	-----------

---

<b>9</b>	<b>Tips on energy saving</b> .....	<b>24</b>
----------	------------------------------------	-----------

---

<b>10</b>	<b>Your guarantee</b> .....	<b>26</b>
-----------	-----------------------------	-----------

---

<b>11</b>	<b>Glossary</b> .....	<b>27</b>
-----------	-----------------------	-----------

---

<b>12</b>	<b>General Information</b> .....	<b>29</b>
-----------	----------------------------------	-----------

---

<b>13</b>	<b>Quick reference guide</b> .....	<b>30</b>
-----------	------------------------------------	-----------

# 1 SYMBOLS AND SAFETY PRECAUTIONS

## 1.1 EXPLANATION OF SYMBOLS

### WARNING SYMBOLS



Safety instructions in this document are framed and identified by a warning triangle which is printed on a grey background.

Signal words indicate the seriousness of the hazard in terms of the consequences of not following the safety instructions.

- **NOTICE** indicates possible damage to property or equipment, but where there is no risk of injury.
- **CAUTION** indicates possible injury.
- **WARNING** indicates possible severe injury.
- **DANGER** indicates possible risk to life.

### IMPORTANT INFORMATION



Notes contain important information in cases where there is no risk of personal injury or material losses and are identified by the symbol shown on the left. They are bordered by horizontal lines above and below the text.

### ADDITIONAL SYMBOLS

Symbol	Meaning
▶	a step in an action sequence
→	a reference to a related part in the document or to other related documents
•	a list entry
-	a list entry (second level)

## 1.2 SAFETY PRECAUTIONS

### IF YOU SMELL GAS!

A gas leak could potentially cause an explosion.

If you smell gas, observe the following rules.

- ▶ Prevent flames or sparks:
  - Do not smoke, use a lighter or strike matches.
  - Do not operate any electrical switches or unplug any equipment.
  - Do not use the telephone or ring doorbells.
- ▶ Turn off the gas at the meter.
- ▶ Open windows and doors.
- ▶ Leave the building and warn your neighbours.
- ▶ Prevent anyone from entering the building.
- ▶ Well away from the building: call the National Gas Emergency Service on 0800 111 999.

### BOILER OPERATION:

This boiler must only be operated by a responsible adult who has been instructed in, understands and is aware of the boiler's operating conditions and effects.

### COMBUSTIBLE AND CORROSIVE MATERIALS:

Chemically aggressive substances can corrode the boiler and invalidate any guarantee.

- Do not store or use any combustible materials (paper, thinners, paints, propellants, cleaning agents etc.) inside or within the vicinity of the appliance.

### FITTINGS AND MODIFICATIONS:

Only a competent engineer can remove the boiler case and carry out any work, in accordance with the Gas Safety (Installation and Use) Regulations.

- Do not remove the boiler case.

Any misuse or unauthorised modifications to the boiler, flue or associated accessories and heating system will invalidate the guarantee.

- Do not modify the boiler or flue system in any way.

Worcester, Bosch Group accepts no liability arising from any such actions. This does not affect your statutory rights.

---

## 2 GENERAL INFORMATION

### SERVICING

---



Ensure that the service engineer completes the Service Record in the Benchmark Checklist after each service. The Benchmark Checklist and service interval record can be found at the rear of the Installation, Commissioning and Servicing Instructions.

---

- The boiler must be serviced regularly by a competent, qualified person, such as a Worcester service engineer or other Gas Safe registered engineer.
- Always use original spares, to help maintain the efficiency, safety and reliability of the boiler and have the Service Record completed in the Benchmark Checklist.

The completed Benchmark Checklist will be required in the event of any guarantee work and may be required by the local Building Control Inspector.

### BENCHMARK STANDARD



The Benchmark initiative is a code of practice to encourage the correct installation, commissioning and servicing of domestic central heating boilers and system equipment.

A “checklist” is dispatched with every boiler. This is a vital document that needs to be completed by the installer at the time of installation. It confirms that the boiler has been installed and commissioned according to the manufacturer's instructions.

The log book provides space for the recording of regular servicing of the boiler/heating system and this can become a valuable document when, for example, you wish to sell the property. The log book will show a potential purchaser that the heating system has received regular professional maintenance and servicing during its lifetime.

The Benchmark initiative aims to:

- Raise standards among professional installers
- Build and maintain high safety standards in the industry
- Improve customer satisfaction levels
- Make a contribution to the nation's commitment to climate change

### 3 OPENING THE CONTROL PANEL COVER

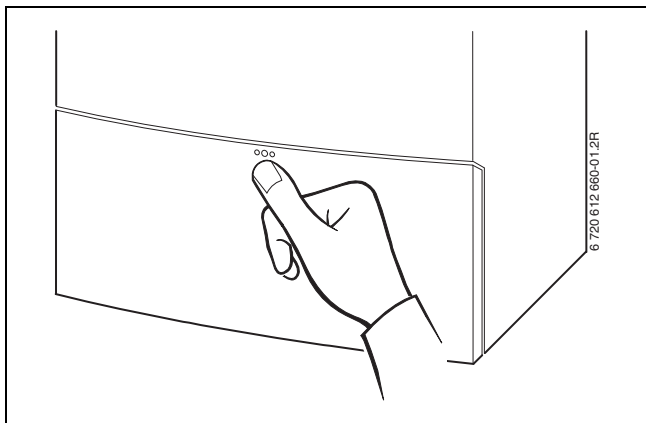

Fig. 1

- ▶ To unlatch the flap, push and release at the point indicated.
- ▶ To close and secure the flap, swing up and push in once to latch.



## 4 OVERVIEW OF CONTROLS

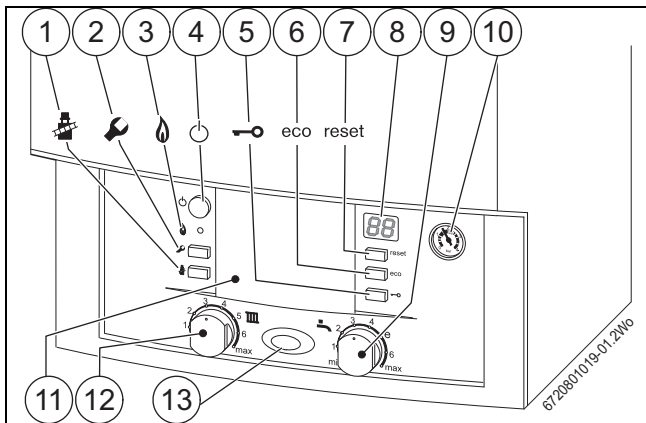

Fig. 2 Basic boiler controls

- [1] Service engineer symbol = boiler is set to maximum or minimum output for service
- [2] Service button for heating engineers
- [3] Indicator for burner operation
- [4] Boiler ON/OFF - does not electrically isolate the boiler
- [5] Button lock
- [6] Eco button
- [7] Reset button
- [8] Display
- [9] Hot Water temperature control
- [10] Pressure gauge
- [11] Position for optional programmer
- [12] Central Heating temperature control
- [13] Indicator for burner operation (ON)/faults (flashing)

## 5 OPERATION

### 5.1 SWITCHING THE APPLIANCE ON/OFF

#### SWITCHING ON FOR THE FIRST TIME

- ▶ Switch appliance on at the main switch.  
The display indicates the current heating water flow temperature.  
The indicator for burner operation/faults is permanently on, as long as the burner is operational.

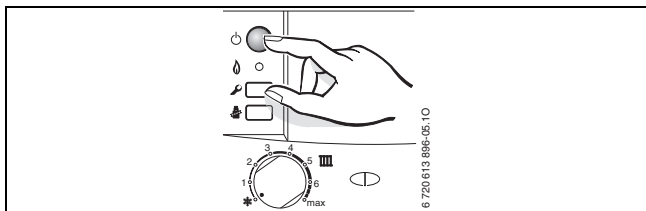



Fig. 3

- Please do not turn your boiler OFF. If you switch your boiler off your frost protection mode will be deactivated.
- Switching the boiler OFF does not electrically isolate the appliance. Your installer must isolate the mains electricity before starting work and observe all relevant safety precautions.
- In the event of an electrical power interruption when the boiler re-starts it will enter a start-up mode for approximately 15 minutes duration.



When the flow temperature alternates with the symbol  on the display, the trap filling function is active.

The trap filling function ensures that the condensate trap is filled after the appliance is first installed or if it has not been used for a long period. For that reason, the appliance is held at minimum heat output for 15 minutes.

## 5.2 SWITCHING ON THE CENTRAL HEATING

The maximum flow temperature can be set to between 35°C and approx. 90°C.



With underfloor heating systems, take care to observe the maximum permissible CH flow temperatures.

- ▶ Turn CH flow temperature control **III** to adjust the max. CH flow temperature according to the central heating system:
  - Underfloor heating: e.g. position **3** (approx. 50°C)
  - Low-temperature heating system: position **6** (approx. 75°C)
  - Heating system for flow temperatures up to 88°C:  
**max** position

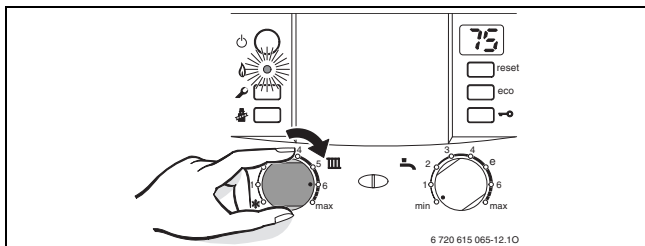

Fig. 4

When the burner is alight, the **green** indicator lights up.

Position	CH flow temperature	Position	CH flow temperature
1	Approx. 35 °C	4	Approx. 60 °C
2	Approx. 43 °C	5	Approx. 67 °C
3	Approx. 50 °C	<b>6</b>	<b>Approx. 75 °C</b>
		max	Approx. 90 °C

Table 1

### 5.3 SYSTEM CONTROLS

These Operating Instructions apply only to the boiler.

Depending on the room thermostat and optional programmer used, some functions may be controlled differently.



Therefore, please read the operating instructions for the heating controller used.



Follow the operating instructions for the heating controller used. Those instructions will tell you

- ▶ how to set the operating mode and the heating curve for weather-dependent controllers,
- ▶ how to adjust the room temperature,
- ▶ how to heat economically and save energy.

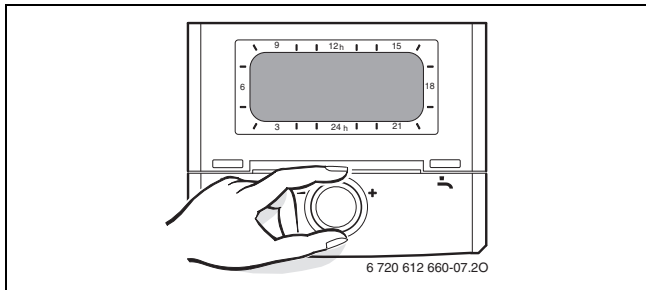



Fig. 5

## 5.4 SETTING HOT WATER TEMPERATURE

- ▶ Set the hot water temperature on the hot water temperature control . The set hot water temperature is shown flashing on the display for 30 seconds.

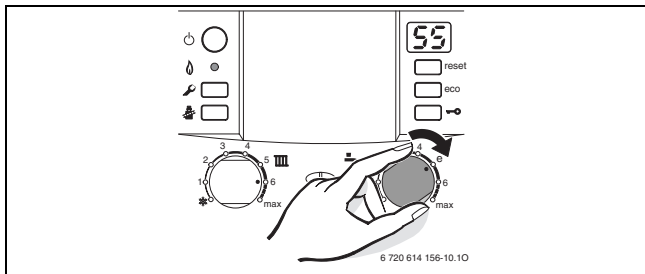

Fig. 6

Hot water temp. control 	Hot water temperature
min to 1	Approx. 40 °C
e	Approx. 50 °C
6 to max	Approx. 60 °C

Table 2

### ECO BUTTON

Pressing and holding the Eco button until it lights up switches between **Comfort mode** and **Economy mode**.

#### COMFORT MODE, ECO BUTTON IS NOT LIT (DEFAULT SETTING)

The appliance is held **constantly** at the set temperature. This means that hot water is available almost instantaneously at the tap. Consequently the appliance will switch on at intervals, even if no hot water is being drawn.

#### ECONOMY MODE, ECO BUTTON LIT

- The water is not heated up until a hot water tap is turned on.
- **Signalling demand.**  
Briefly turning a hot water tap on and then off signals demand so that the water is then heated up to the set temperature.



Signalling demand enables maximum gas and water economy.

---

## 5.5 FROST PROTECTION

Frost Protection is active as long as there is power to the boiler.

If the temperature within the boiler falls below 8°C the pump will run to circulate water and prevent the system freezing. If the temperature within the boiler falls below 5°C the boiler will fire periodically, bringing the boiler temperature up to 12°C to avoid the possibility of the system freezing.

This process will be repeated until such time that the boiler temperature does not drop below 5°C.

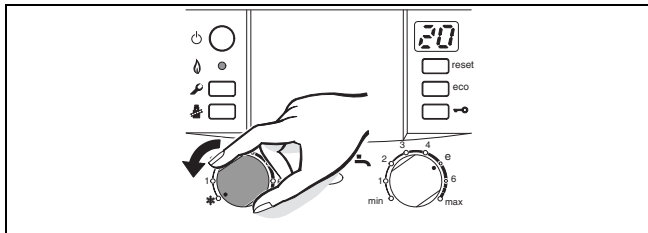



Fig. 7

## 5.6 BUTTON LOCK

The button lock affects the CH flow temperature control, the hot water temperature control and all buttons except the main switch and the service engineer mode button.

To switch on the button lock:

- ▶ Press and hold the button until the display shows  .

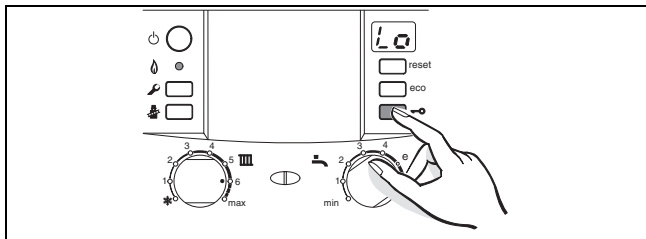

Fig. 8

To switch off the button lock:

- ▶ Press and hold the button until the display shows only the CH flow temperature.



## 5.7 BOILER RESET

In the unlikely event of a fault occurring while the appliance is in operation:

The reset button will flash once per second and the mains indicator (blue light) also flashes. The display will show a fault code.

To reset the boiler, press the reset button until  is displayed. The reset button will no longer be illuminated and the blue light will stop flashing.

If the reset was successful the boiler will return to normal operation, depending on programmer and room thermostat settings.

If the reset was not successful then the blue light will continue to flash and a fault code will be displayed again.

Info symbol: If the fault remains and cannot be cleared by pressed the reset button, or if the fault persists please contact Worcester, Bosch Group for assistance on 0330 123 3366.

In the event of a fault, the reset button will flash once per second and the blue mains indicator light will flash.

## 5.8 DISPLAY CODES

Display code	Description
8n	Inspection due
86	Button lock active
8H	Trap filling function active
89	Air purge function active
80	Excessively rapid increase in CH flow temperature (temp. gradient monitoring). Heating mode is disabled for two minutes.
8r	Not applicable in the UK.
88	Not applicable in the UK

## 5.9 EXTREME COLD WEATHER

In some instances where the condensate pipe work is run externally or in an unheated area, such as a garage, the condensate pipe work can be at risk of freezing, even if well insulated.

A frozen/blocked condensate pipe will cause the boiler to shut down.



**WARNING:** Falling hazard!

Failure to follow this guidance may result in personal injury.

- ▶ Only attempt to thaw a condensate pipe that is at ground level, and that is easily accessible.
- ▶ Never attempt to thaw a condensate pipe that is at height.



**CAUTION:** Pipe damage

- ▶ **DO NOT** use boiling water to thaw the condensate pipe!

If the condensate pipe has frozen:

- ▶ Locate the blockage.

It is likely that the pipe is frozen at the most exposed point outside the building or where there is an obstruction to flow.

This could be the open end of the pipe, at a bend or elbow, or where there is a sag in the pipe in which condensate can collect.

The location of the blockage should be identified as closely as possible before taking further action.

- ▶ Thaw the frozen pipe.

The pipe can be thawed by applying a hot water bottle, a microwaveable heating pack (the sort used for muscular aches and pains) or a cloth soaked in hot water to the exterior of the pipe, close to the point of blockage.

Hot water, but not boiling, can also be poured onto the pipe from a watering can or similar container.

- ▶ Once the pipe has been thawed the boiler must be reset, press the reset button for five seconds and wait two to three minutes for the boiler to restart.

- ▶ If the boiler does not restart, contact Worcester, Bosch Group Appointments team on: 0330 123 3366.
- ▶ Contact your installer in order to find a permanent solution to the problem.

## 6 SYSTEM PRESSURE

### 6.1 SEALED HEATING SYSTEMS

This boiler is fitted to a sealed heating system which is pre-pressurised.

Your installer will advise you of the minimum and maximum pressure indicated on the pressure gauge.

- ▶ Check regularly that the pressure is maintained.

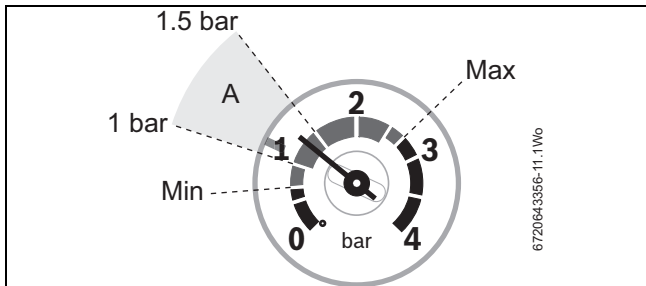

Fig. 9 Optimum pressure when the boiler is cold (area A)

- ▶ Contact your installer or maintenance engineer if a permanent significant decrease or increase in pressure is indicated on the pressure gauge.

The filling method will be an external filling loop, fitted valves and flexible hose.



**NOTICE:** To comply with the Water Authority regulations you must disconnect the external filling loop after re-pressurisation.

## 6.2 EXTERNAL FILLING LOOP

Locate the external filling loop and follow the instructions for re-pressurising.



**NOTICE:** If the filling loop does not look like the one shown in the figure below or you cannot find your filling loop, contact your installer.

- ▶ Ensure that the isolating valves are shut before removing the blanking caps. The valves are shut when the handle or screwdriver slot is at 90° to the valve.
  1. Unscrew the blanking cap(s) from the isolating valves.
  2. Attach the filling loop and screw on, hand-tight, to both isolating valve.
  3. The handle/screwdriver slot has only to be turned through 90° (¼ turn) to open the valve.
  4. The handle/screwdriver slot will then be in-line with the valve, i.e. vertical.

### FILLING PROCEDURE:

- ▶ Open one of the valves, do not turn passed 90° i.e. ¼ turn.
- ▶ Monitor the water pressure gauge and slowly open the second valve until water can be heard flowing and the pressure gauge starts to rise.
- ▶ When the water pressure reaches 1 to 1.5 bar, close the valve, this will stop the system filling.
- ▶ Once the system has been re-pressurised, to the correct pressure, close the other valve.  
Ensure both valves are closed before removing the hose.
- ▶ Remove the hose and replace the blanking cap(s).

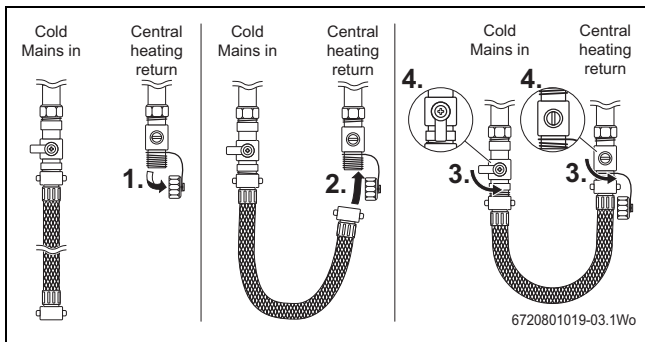

Fig. 10 External filling loop



If the pressure gauge reads more than 1.5 bar as a result of over filling, please bleed one radiator until the pressure gauge returns to between 1 and 1.5 bar.

---

## 7 FAULT OR BREAKDOWN

This boiler is supported in the UK and Eire by Worcester, Bosch Group. Specialised Service Engineers are available to attend a boiler breakdown.



Invoices for attendance and repair work carried out on this boiler by any third party will not be accepted.

---

No charge will be made for parts and/or labour providing:

- A boiler fault is found and the appliance has been installed within the last 12 months. Reasonable evidence of this must be supplied on request. i.e. the Benchmark Checklist.

A call-out charge will be made where:

- The boiler has been installed for over 12 months.
- Evidence cannot be provided that the first year service inspection has been carried out (i.e. an entry in the Benchmark Checklist).
- Our Field Service Engineer finds no fault with the boiler.
- The cause of breakdown is misuse or with other parts of your plumbing/heating system, or with equipment not supplied by Worcester, Bosch Group.

### TECHNICAL SUPPORT



**No fault is found on over 30% of all service calls.**

In the case of a suspected fault, refer to the fault finding section of this guide.

---

In the event of a boiler fault or breakdown please contact Worcester, Bosch Group appointments team on 0330 123 3366.

Your advisor will arrange for an engineer to call with the minimum of delay; under normal circumstances this will be from 1 - 3 working days (excluding weekends) for priority breakdown situations (no hot water and/or heating).

---

## 8 ENVIRONMENT / DISPOSAL

Environmental protection is a fundamental corporate strategy of the Bosch Group. The quality of our products, their economy and environmental safety are all of equal importance to us and all environmental protection legislation and regulations are strictly observed.

We use the best possible technology and materials for protecting the environment taking account of economic considerations.

### PACKAGING

We participate in the recycling programmes of the countries in which our products are sold to ensure optimum recycling.

All of our packaging materials are environmentally compatible and can be recycled.

---



### USED APPLIANCES

- ▶ All Greenstar gas boilers are 100% recycleable. The various assemblies can be easily dismantled and synthetic materials are marked accordingly. Assemblies can be sorted by composition and passed on for recycling.
- 

## 9 TIPS ON ENERGY SAVING

### HEATING ECONOMICALLY

The boiler provides a high level of comfort whilst keeping gas consumption and the environment effects as low as possible.

The gas supply to the burner is controlled according to the level of demand for heat. The boiler operates with a low flame if the demand for heat reduces. The technical term for this process is modulating control.

Modulating control reduces temperature fluctuations and provides an even distribution of heat throughout the home. This means that the boiler may stay on for relatively long periods of time but will use less gas than a boiler that continually switches on and off.



## **CENTRAL HEATING SYSTEMS WITH ROOM THERMOSTAT/THERMOSTATIC RADIATOR VALVES**

With modern heating systems set around a 20°C heat loss, the optimum setting for a condensing boiler will be approximately between one and two on the central heating temperature control. The system must be balanced correctly and the radiators may need upgrading. This allows the boiler to condense as much as possible for the central heating system.

The temperature of each room can be set individually (except primary room with the room thermostat) using the thermostatic radiator valves.

## **ROOM THERMOSTATS**

Reducing the setting of the room thermostat by 1°C can reduce fuel consumption by up to 10%.

## **NEW CONTROL SYSTEMS**

Upgrade your heating control system if necessary with the latest equipment available.

## **ROOF INSULATION**

Around 30% of the heat loss from a property is through the roof. Replace any old insulation with new insulation, preferably of around 200mm thickness or more.

## **WINDOW FRAMES**

Single glazed windows, particularly those with steel frames, can lose a great deal of heat. Consideration should be given to replacement with PVCu or wooden framed double glazed units.

## **RADIATORS**

If a radiator is sited underneath a window, its performance will be affected if the curtains are allowed to drape over the radiator. Shelves fitted above or in front of the radiator should also be avoided.

It is advisable to manually adjust all thermostatic radiator valves every 2 - 3 months to prevent them sticking. Ensure radiator valves are correctly set and not damaged.

## DRAUGHTS

Try to ensure that draughts around doors, windows, letterboxes and keyholes etc. are reduced by using a suitable draught excluder.



**WARNING:** Air vents

- ▶ Do not block or seal any air vents that are installed to ensure that the central heating boiler operates safely.

## CURTAINS

Lined curtains, or heavier full length curtains can provide excellent insulation. However, always ensure that the curtains do not drape over radiators.

---

## 10 YOUR GUARANTEE

This boiler has a guarantee against faulty materials or workmanship for a period of 1 year from the date of installation subject to the following terms and conditions:

- During the period of this guarantee any components of the boiler which are proven to be faulty or defective in manufacture will be exchanged or repaired free of charge by Bosch Thermotechnology Ltd.
- The householder may be asked to prove the date of installation, that the boiler was correctly commissioned and, where appropriate, the first year's service has been carried out to the satisfaction of Bosch Thermotechnology Ltd., when requested. These should be documented as a part of the Benchmark Checklist.
- The boiler has been used only for the normal domestic purposes for which it was designed.

This guarantee does not affect your statutory rights.

### GUARANTEE REGISTRATION

Your Greenstar boiler carries a one year guarantee against faulty material or manufacture subject to Terms and Conditions.

To read the full Terms & Conditions please visit us online at [www.worcesterbosch.co.uk/guarantee](http://www.worcesterbosch.co.uk/guarantee). The Guarantee Registration form is available on this same

page and can be completed and submitted electronically.

Alternatively please telephone one of our Guarantee Registration advisors on 0330 123 2552.

Your statutory rights are not affected by the manufacturers guarantee.

### **FOR YOUR OWN RECORD:**

Please ensure that the Benchmark Checklist has been completed by your installer or service engineer.

Model	
Serial No. <sup>1)</sup>	
Type/size	
Date of installation	
Name of Installer	
Telephone number of Installer	

- 1) See boiler identification label on boiler fascia or Benchmark Checklist in the back of the Installation, Commissioning & Servicing Instructions.

---

## **11 GLOSSARY**

### **Central heating systems**

All radiators must be heated at an even rate. If the top of a radiator is at a lower temperature than the bottom then it should be bled by releasing air through the bleed screw at the top of the radiator.

You must re-pressure the system after venting the radiators.

Ask your installer to show you how this is done.

This boiler is fitted to a sealed system. Should water leaks be found or if excessive bleeding is required, then a service engineer must be contacted to inspect the installation and rectify any fault.

Only additives that are compatible with aluminium may be used in the system. Any incompatible additive used will invalidate the guarantee.

**Plumbing and Condensate drain**

This is a condensing boiler and the flue terminal will, at times give out a plume of water vapour. This is quite normal.

The boiler produces condensate which is discharged regularly by a syphon within the boiler via a plastic pipe to a drain. This pipe must not be blocked or altered in any way.

**Room thermostat / programmer**

A room thermostat / programmer must be fitted to control the central heating. This controls the times and temperatures of the central heating, preventing the boiler from firing unnecessarily. Refer to the instructions supplied with the thermostat and programmer for further information.

**Thermostatic radiator valves**

Thermostatic radiator valves must be fitted in sleeping accommodation. It is recommended that this type of valve is fitted to all but one of the radiators. The remaining radiator, where the room thermostat is located, must be uncontrolled and left open.

**Pump over run function**

After the boiler has finished a demand for central heating or hot water, the pump may continue to run for a short while to dissipate the heat from within the boiler.

**Pump anti-seizure**

If there has been no heating demand for 24 hours the boiler will run the system pump for a few seconds to reduce the possibility of pump seizure during long periods of inactivity.

**SEDBUK**

Seasonal Efficiency of Domestic Boilers in the UK.

## 12 GENERAL INFORMATION

### CLEANING THE OUTER CASING

Wipe down with a damp cloth. Do not use any abrasive or corrosive cleaning agents.

### KEEP THESE INSTRUCTIONS SAFE



When you have finished reading these instructions, you can fold out the quick guide (→ chapter 13) and place the booklet inside the control panel cover for safekeeping.

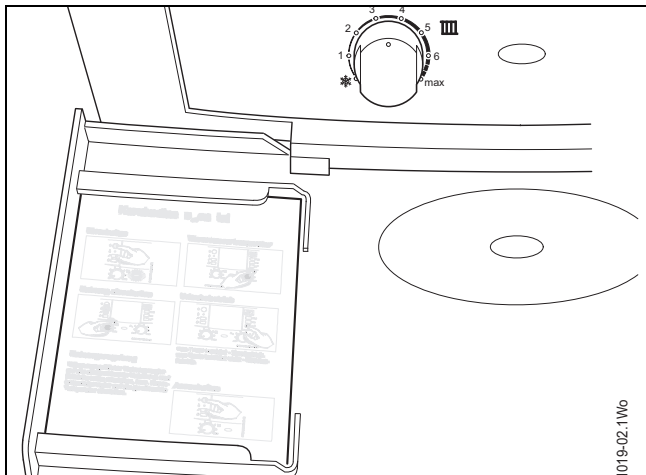

1019-02.1W6

## 13 QUICK REFERENCE GUIDE

### Switching on

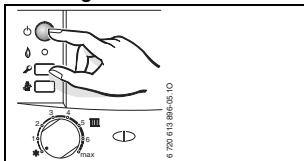

### Switching on the Central heating

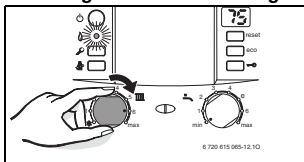

### Setting the Hot Water temperature

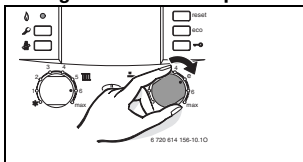

**Eco button not lit – Comfort mode**

**Eco button lit – Economy mode**

### Button lock

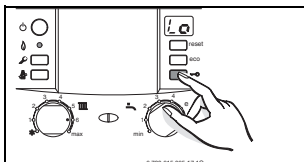

### Frost protection

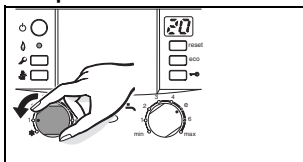

## NOTES

**WORCESTER, BOSCH GROUP:**

TECHNICAL SUPPORT: 0330 123 3366

APPOINTMENTS: 0330 123 9339

SPARES: 0330 123 9779

LITERATURE: 0330 123 9119

TRAINING: 0330 123 0166

SALES: 0330 123 9669

Worcester, Bosch Group  
Cotswold Way, Warndon, Worcester WR4 9SW.

Tel. 0330 123 9559

Worcester, Bosch Group is a brand name of  
Bosch Thermotechnology Ltd.

[worcester-bosch.co.uk](http://worcester-bosch.co.uk)

6 720 811 923

