

# USER INSTRUCTIONS

## AIR TO WATER SPLIT HEAT PUMP

### GREENSOURCE HYDROLIGHT AND HYDROCOMFORT

OUTDOOR UNIT 7.5, 10, 11 AND 12, 1 PHASE AND 3 PHASE MODELS

HYDROLIGHT 8 AND 16 1 PHASE

HYDROCOMFORT 8 AND 16 1 PHASE AND 3 PHASE

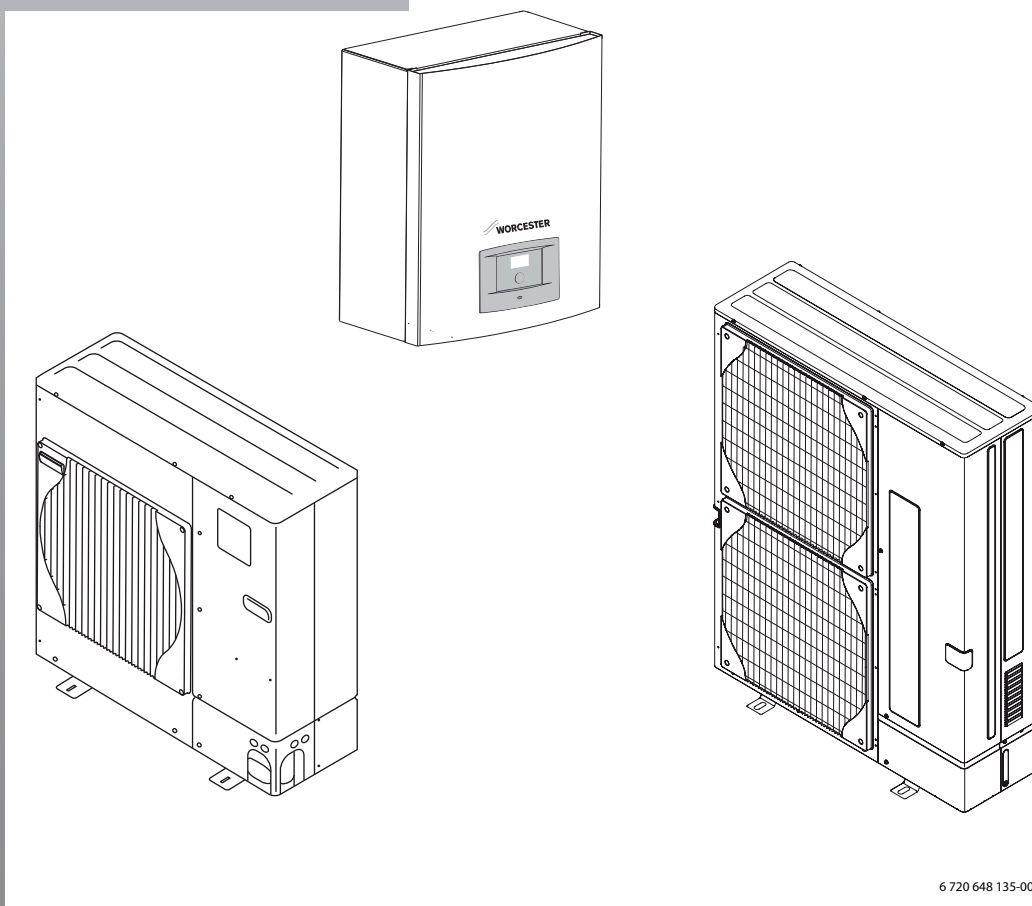

**TABLE OF CONTENTS**

**1 Key to symbols and safety instructions ..... 2**

1.1 Key to symbols ..... 2

1.2 Safety instructions ..... 3

---

**2 The Benchmark scheme ..... 3**

---

**3 Air source Heat pump operation ..... 3**

3.1 Selection and sizing of a heat pump ..... 3

---

**4 Heat emitters ..... 3**

---

**5 Use ..... 4**

5.1 General ..... 4

---

**6 Component parts ..... 4**

---

**7 Control panel ..... 4**

7.1 Additional electric heat gives more output ..... 4

7.2 Hot water is given priority over heating water ..... 5

7.3 Automatic defrosting ..... 5

7.4 The control unit's control method for heating ..... 5

7.5 control Panel function ..... 5

---

**8 Control panel ..... 5**

8.1 Control panel parts ..... 5

8.2 Control panel function ..... 5

8.3 Menu tabs ..... 6

---

**9 Menu ..... 6**

9.1 Temperatures ..... 6

9.2 Blocking ..... 6

9.3 Menu ..... 7

9.4 Set the heating ..... 7

9.5 Extra hot water ..... 7

---

**10 Advanced menu ..... 7**

10.1 Overview ..... 7

10.2 Heating ..... 8

10.3 Hot water ..... 9

10.4 Timers ..... 10

10.5 Setting the clock ..... 10

10.6 Alarm ..... 10

10.7 Access level ..... 11

10.8 Return to factory settings ..... 11

10.9 Deactivate alarm buzzer ..... 11

10.10 Program version ..... 11

---

**11 LCD room controller (ACCESSORY) ..... 11**

---

**12 Maintenance ..... 12**

12.1 Remove dirt and leaves ..... 12

12.2 Protective covers ..... 12

12.3 Evaporator ..... 12

12.4 Snow and ice ..... 12

12.5 Moisture ..... 12

12.6 Leakage tests ..... 12

12.7 Checking the safety valves ..... 12

12.8 Filter ..... 12

**13 Error management ..... 13**

13.1 Alarm log and Info log ..... 13

13.2 Example of an alarm: ..... 13

13.3 blank menu display ..... 13

13.4 All alarms, warnings and information windows ..... 13

13.5 Alarm window ..... 13

13.6 Warning message ..... 14

13.7 Information window ..... 15

13.8 Info symbol ..... 15

**14 Factory settings ..... 16**

14.1 Factory settings ..... 16

**15 The guarantee ..... 18**

**1 KEY TO SYMBOLS AND SAFETY INSTRUCTIONS**

**1.1 KEY TO SYMBOLS**

**WARNINGS**

	Warnings in this document are framed and identified by a warning triangle which is printed on a grey background.
---	--

Keywords indicate the seriousness of the hazard in terms of the consequences of not following the safety instructions.

- **NOTICE** indicates that material damage may occur.
- **CAUTION** indicates that minor to medium injury may occur.
- **WARNING** indicates that serious injury may occur.
- **DANGER** indicates possible risk to life.

**IMPORTANT INFORMATION**

	Important information in cases where there is no risk of personal injury or material losses is identified by the symbol shown on the left. It is bordered by horizontal lines above and below the text.
---	---

**ADDITIONAL SYMBOLS**

Symbol	Meaning
▶	a step in an action sequence
→	a reference to a related part in the document or to other related documents
•	a list entry
-	a list entry (second level)

Table 1

## 1.2 SAFETY INSTRUCTIONS

### GENERAL

- ▶ Read the user manual carefully and keep it safe for future use.

### INSTALLATION AND COMMISSIONING

- ▶ The product must only be installed and commissioned by competent persons.

### RISK OF DAMAGE DUE TO OPERATOR ERROR

Operator errors can result in injury and damage to property.

- ▶ Ensure that children never operate this appliance unsupervised or play with it.
- ▶ Ensure that only personnel who can operate this appliance correctly have access to it.

### SERVICE AND MAINTENANCE

- ▶ Only competent personnel may carry out repairs. Incorrect repairs can lead to serious risks to the user, and a reduction in savings.
- ▶ Only use original Bosch spare parts.
- ▶ Service and maintenance must be carried out annually by an competent person.

## 2 THE BENCHMARK SCHEME

Worcester, Bosch Group is a licensed member of the Benchmark Scheme which aims to improve the standards of installation and commissioning of domestic heating and hot water systems in the UK and to encourage regular servicing to optimise safety, efficiency, performance and to comply with the F gas regulations.

Please ensure that the installer has fully completed the Benchmark Checklist on the inside back pages of the installation instructions supplied with the product and that you have signed it to say that you have received a full and clear explanation of its operation. The installer is legally required to complete a commissioning checklist as a means of complying with the appropriate Building Regulations (England and Wales).

All installations should be made in accordance with MCS/MIS 3005.

This product should be serviced regularly to optimise its safety, efficiency and performance. The service engineer should complete the relevant Service Record on the Benchmark Checklist after each service.

The Benchmark Checklist may be required in the event of any warranty work and as supporting documentation relating to home improvements in the optional documents section of the Home Information Pack.

## 3 AIR SOURCE HEAT PUMP OPERATION

As the outside temperature gets colder, the heat demand of a house increases and the output of an air source heat pump will decrease. Eventually it becomes so cold outside that the output of the heat pump alone is not able to heat the building effectively. The Greensource Split range of air source heat pumps therefore allow for either monoenergetic (with Hydrocomfort module) or bivalent (with Hydrolight module) operation.

Monoenergetic means that in the event of very low external temperatures a 3-stage electrical heater in the indoor unit will automatically be activated to provide additional heat and keep the building warm.

In bivalent operation a second heating appliance (e.g. gas or oil boiler) is used to supplement the heat load.

## 3.1 SELECTION AND SIZING OF A HEAT PUMP

It is essential that heat pump systems are designed to operate efficiently in order to meet the building heating needs and the expectations of the customer. In order to achieve this, the following design activities must be completed prior to installation:-

- Pre-design assessment - Determine the suitability of a heat pump system for the building based on the customer requirements, expectations and building type.
- Detailed design - Complete building heat loss calculations and domestic hot water usage assessment.
- Specification - Select a suitable heat pump and system components based on the detailed design. Calculate and communicate the predicted energy use and running costs of the system to the customer.

A suitable design methodology for the above is detailed in MIS3005, the Microgeneration Certification Scheme (MCS) heat pump installer standard. Worcester, Bosch Group recommended that this standard is followed for heat pump systems. The standard covers the design, installation and commissioning requirements to ensure that 100% of the building heat loss can be met efficiently by the heat pump system. A heat pump system must be designed to this standard to be eligible for government financial incentives e.g Renewable Heat Incentive (RHI).

The Worcester Bosch Group design team offer a heat pump sizing service which is MCS compliant. To request this service, download and submit the form using the guidance notes from our website address:

[www.worcester-bosch.co.uk/hp](http://www.worcester-bosch.co.uk/hp)

## 4 HEAT EMITTERS

Worcester, Bosch Group heat pumps are fitted with weather compensation controls as standard. However, for a heat pump to perform to its highest energy efficiency, the central heating emitter circuit should be designed so that the flow temperature is as low as possible.

As a guide, the system should be designed using the following maximum flow temperatures;

- Underfloor heating: 35-40 °C
- Radiators: 45-50 °C

If underfloor heating has been installed, it is important to remember that the underfloor system designer should have been informed that the heat source will be from an air source heat pump. It is also important to remember that radiators should have been correctly sized to work effectively with lower flow temperatures.

A tool to aid installers and end users to understand the relevance of building heat loss and heat emitter selection on heat pump performance, has been created by the joint trade associations. The 'Heat Emitter Guide' can be downloaded from the following website:

[www.microgenerationcertification.org](http://www.microgenerationcertification.org)

## 5 USE

### 5.1 GENERAL



Cooling is not a working function in this unit and all settings are not to be altered concerning cooling.

Worcester Greensource split air to water heat pumps work on the principle that they retrieve energy from the outside air in order to provide water-based heating and domestic hot water.

The heat pump can be connected to one of two options either a Hydrolight or Hydrocomfort indoor unit. The Hydrolight is able to be connected to any existing electric/oil/gas fired boiler, which provides a complete heating unit. The Hydrocomfort unit has an additional heater if the heat pump cannot manage all heating itself, e.g. if the outdoor temperature is too low.

The heating unit is controlled by a control panel called a Rego 800, which is in the Hydrolight/Hydrocomfort unit. The control panel controls and monitors the system using different settings for heating, hot water and other operations. The settings are made by the installer and the user via a control panel.

Once the heat pump has been installed and started, there are a number of points that should be checked regularly. This may concern an alarm triggering or performing basic maintenance actions. In the first instance the user should try to rectify this and this manual helps to describe each step. If the problem is repeated, you should contact your installer.



If a solar pump station and panels are installed these are controlled by its own system and not by the heat pumps control panel. For installation and settings refer to the installation instructions of the solar pump station and its control.

## 6 COMPONENT PARTS

The heating installation consists of two parts; the heat pump is installed outdoors and the Hydrolight/Hydrocomfort unit is installed indoors. The control unit is in the Hydrolight/Hydrocomfort unit.



Figure 1 describes a typical installation.

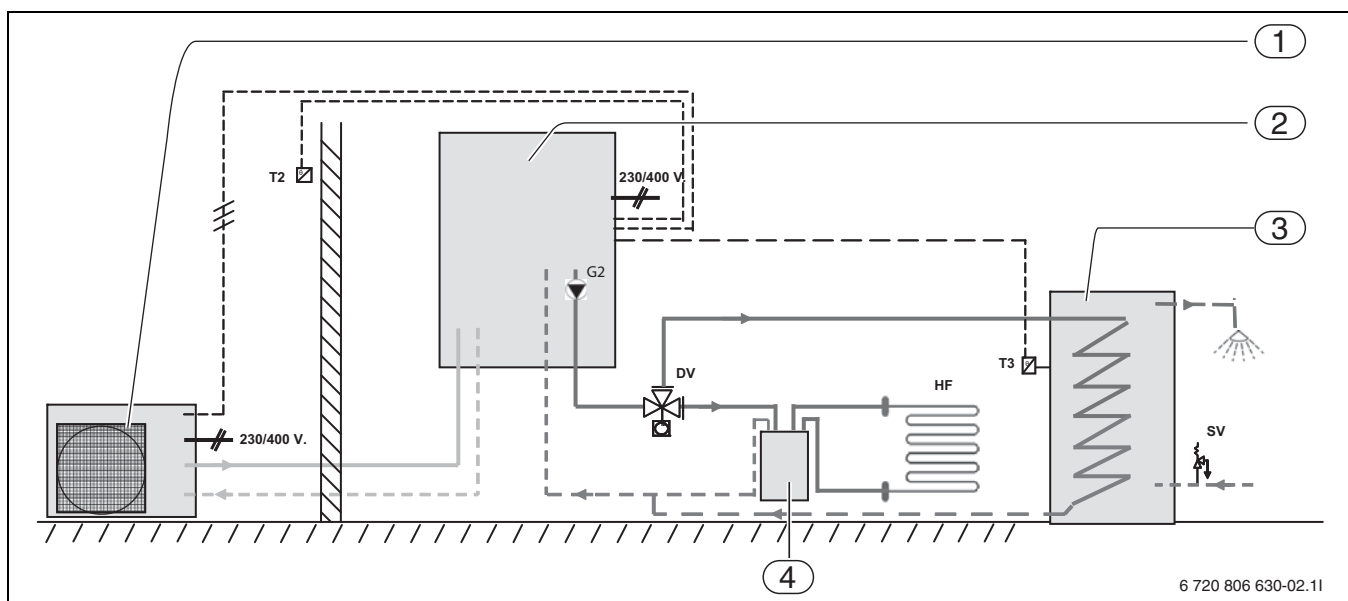

Fig. 1 Example of outdoor unit ODU, Hydrolight/Hydrocomfort unit, DHW cylinder and underfloor heating system

- [1] Outdoor unit ODU
- [2] Hydrolight/Hydrocomfort unit
- [3] Heat pump domestic hot water cylinder
- [4] Buffer tank
- [T2] Outdoor temperature sensor
- [T3] DHW cylinder temperature sensor
- [G2] Heating circuit pump
- [HF] System for underfloor heating
- [DV] 3-way valve
- [SV] Safety valve

## 7 CONTROL PANEL

The control panel controls and monitors the heating and hot water production with the heat pump and additional heat inputs either from a boiler or the additional electric heater. The monitoring function shuts

down the heat pump in the event of operational disturbances so as to prevent damage to critical parts of the heat pump.

### 7.1 ADDITIONAL ELECTRIC HEAT GIVES MORE OUTPUT

The additional electric heater or boiler input heating is only required when the heat pump is unable to meet higher temperature heating requirements or when it has stopped due to an outdoor temperature that is too low. The supplementary heat can be provided either through the Hydrolight via the boiler input or the Hydrocomfort and the inbuilt supplementary electric heater. Note:- that when the heat pump is running, the additional heat source only supplies the extra heat that the heat pump cannot produce. When the heat pump is once more able to meet the heating demand, the additional heat is automatically switched off.

## 7.2 HOT WATER IS GIVEN PRIORITY OVER HEATING WATER

In a house with water based heating a difference is made between heating water and hot water. The heating water is for radiators and under floor heating circuits and hot water is for showers and taps.

The control panel makes sure the heating of hot water is given priority over the heating of the heating water. The hot water cylinder is fitted with a sensor that senses the temperature of the hot water.

## 7.3 AUTOMATIC DEFROSTING

Ice can form on the outdoor heat pump on a component called an evaporator at an outside temperature below +10°C. When ice forms to an extent that it obstructs the air flow through the evaporator automatic defrosting starts.

Defrosting is controlled by a four-way valve. The valve reverses the flow of the refrigerant in the circuit so that the hot gas from the compressor melts the ice on the evaporator fins. The water produced is non acidic.

## 7.4 THE CONTROL UNIT'S CONTROL METHOD FOR HEATING

The control panel controls heating production based on a outdoor sensor that can be combined with room controllers (accessory). This means that a sensor is mounted on the external wall of the house (north facing wall). A room controller (accessory) can be placed in a central position in the house. This is connected to the heat pump and provides the control unit with information about the current outdoor and room temperatures. The heat pump adapts the heating inside the house automatically depending on the outdoor temperature.

The user determines the temperature of the heating system in relation to the outdoor temperature, using the room controller (accessory) and the heat curve on the control panel. The curve indicates the radiator flow temperature for in relation to the outdoor temperature. Selecting a lower curve gives a lower flow temperature and therefore higher energy savings.

The room controller signal affects the heat curve's flow temperature. For example, it falls when the room controller shows a higher temperature than the one set.



It is only the room where the room controller is located that can influence regulation of the temperature.

## 7.5 CONTROL PANEL FUNCTION

When a heat pump is installed, it must be set-up for a specific operating mode. An operating mode relates to the heat pump's working situation which is dependent on the prevailing conditions, for example, whether an electric, oil-fired or gas boiler is to be connected and the type of space heating emitters fitted.

The installer must set up the heat pump in accordance with the required operation and respective conditions.



The heat pump stops automatically at outside temperatures less than approx. -15 °C. The heating and DHW production is then provided by the additional electr. heater or the 2nd heat appliance in the Hydrolight/Hydrocomfort unit.

# 8 CONTROL PANEL

All settings are made in the control panel and any alarms can be viewed. Control panel and control unit are in the Hydrolight/Hydrocomfort unit.

## 8.1 CONTROL PANEL PARTS

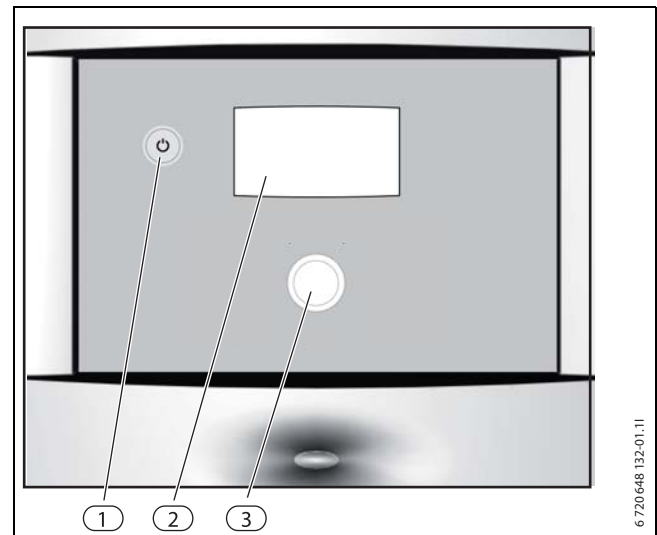

Fig. 2 Overview of the user interface

- [1] ON/OFF switch
- [2] Display
- [3] Rotary selector

### MENU DISPLAY

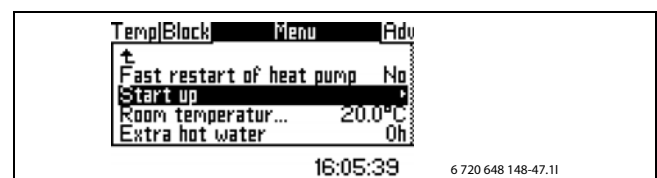

Fig. 3

### MENU DIAL

The menu dial is used to navigate between the menu windows and to change the values of different settings. The menu dial is also used to confirm selections.

### ON/OFF SWITCH

The on/off switch button is used to start and switch off the appliance.

## 8.2 CONTROL PANEL FUNCTION

The menu dial is used to navigate the menus.

- ▶ Turn the rotary selector anticlockwise to go down in the menus.
- ▶ Turn the menu button clockwise to go up in the menus.
- ▶ Once you have marked the required selection, press the rotary selector to confirm.

At the top and bottom of each sub menu there are back arrows to take you back to the previous menu.

- ▶ Press the rotary selector if the arrow is marked.

### 8.2.1 SYMBOL OVERVIEW

Symbols for different functions and components that are in operation are displayed in the lower part of the menu window.

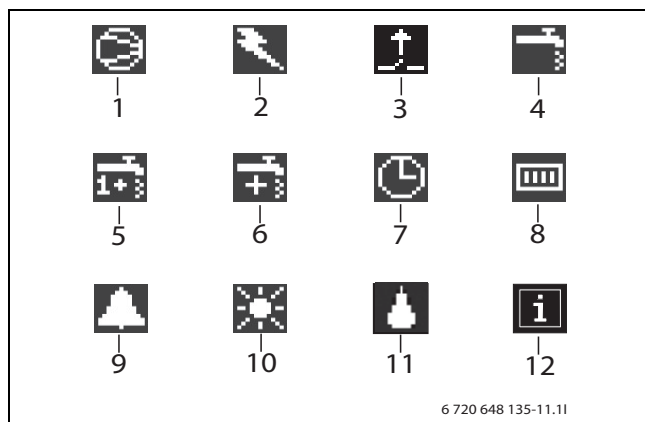

Fig. 4 Overview of symbols

- [1] Compressor
- [2] Additional heat input (additional electric heater (Hydrocomfort) heater or 2nd heat appliance (Hydrolight))
- [3] External input
- [4] DHW mode
- [5] DHW peak
- [6] Additional hot water
- [7] Time control
- [8] Heating Mode
- [9] Alarm
- [10] Holiday mode
- [11] defrosting
- [12] Info-Icon

### 8.3 MENU TABS

The menus are divided into four different tabs for different reasons.

- **Temperature** - overview via heating settings
- **Blocking** - blocking functions
- **Menu** - the most popular menu items
- **Advanced menu** - additional menu items

Heating unit users only see what is available in the customer levels.

## 9 MENU



The menus for heating system 2 are only shown if a 2nd heating circuit is installed in the system. This is for a mixed heating circuit of underfloor and radiator systems.



Wait at least twenty-four hours when increasing or decreasing the heating before making a new adjustment either via the heat curve on the control panel or via the optional room controller (accessory).



Cooling is not an option in this unit.

### 9.1 TEMPERATURES

Under the **Temperatures** display, the current temperatures for the sensors which are important for controlling the heating and the hot water are displayed.

- ▶ Select menu option **Temperatures**.

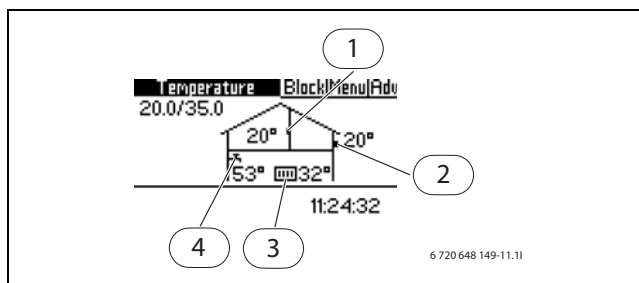

Fig. 5

- [1] Room temperature sensor (accessory)
- [2] Outside temperature sensor supplied
- [3] Flow temperature sensor supplied
- [4] DHW temperature sensor (accessories)

**Room temperature controller** is only shown if it is installed. The menu shows the temperature in the room where the sensor is installed.

**Outdoor temperature sensor** shows the outdoor temperature to be fitted on a north facing wall.

**Flow temperature sensor** shows the heating unit's flow temperature, i.e. the temperature of the heating water that is piped to the heating system.

**Hot water temperature sensor** shows the temperature in the heat pump hot water cylinder. The temperature could be approximately 5°C lower than the temperature of the hot water inside the cylinder.



The values for V and H are also displayed in the menu window. In the example, V is 20.0°C and H 35°C. For a description of V and H (→Chapter 10.2).

### 9.2 BLOCKING

The following blocking options can be found in the controller:

#### 9.2.1 BLOCK ADDITIONAL HEAT

The function is used to allow or block additional electric heater or 2nd heat appliance. The factory setting is **No**.

To block the additional heat:

- ▶ Select **Block additional heat**
- ▶ Select **Yes**.
- ▶ Select **Save** to save the change or **Cancel** to return without saving.

#### 9.2.2 BLOCK DOMESTIC HOT WATER

The function is used to allow or block domestic hot water. The factory setting is **No**.

To block domestic hot water:

- ▶ Select **Block hot water**.
- ▶ Select **Yes**.
- ▶ Select **Save** to save the change or **Cancel** to return without saving.

#### 9.2.3 BLOCK CENTRAL HEATING

The function is used to allow or block central heating. The factory setting is **No**.

To block the central heating:

- ▶ Select **Block heating**.
- ▶ Select **Yes**.
- ▶ Select **Save** to save the change or **Cancel** to return without saving.

### 9.3 MENU

The **Menu** shows the functions that your heating unit is set for. For example it shows **Extra hot water** only if a water cylinder is connected.

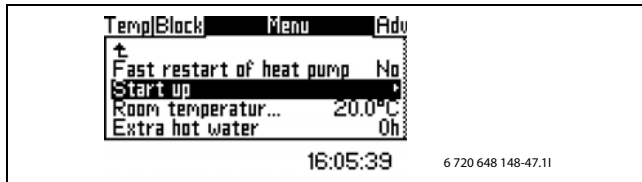

Fig. 6

### 9.4 SET THE HEATING

Depending on whether the system is equipped with a room temperature controller or not, two options for setting up the heating system are available.

#### ROOM TEMPERATURE CONTROLLER NOT INSTALLED:

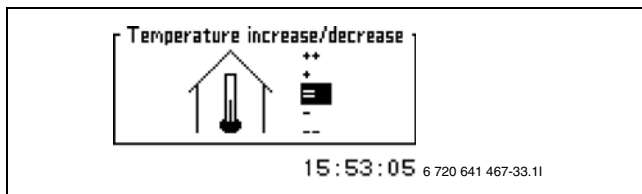

Fig. 7

- ▶ Select menu option **Temperature increase/decrease**.
- ▶ Select one of the options below:

++	Much hotter	Approx. +1 °C
+	Hotter	Approx. +0.5 °C
=	Unchanged	
-	Colder	Approx. -0.5 °C
--	Much colder	Approx. -1 °C

Table 2

- ▶ Select **Save** to save the change or **Cancel** to return without saving.

#### SET HEATING WITH ROOM TEMPERATURE CONTROLLER (ACCESSORY)

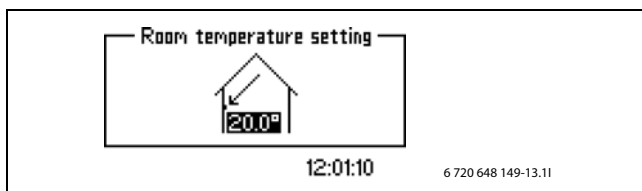

Fig. 8

- ▶ Select menu option **Room temperature setting**.
- ▶ Setting the required room temperature. Minimum = +10°C, maximum = +35°C.
- ▶ Select **Save** to save the change or **Cancel** to return without saving.

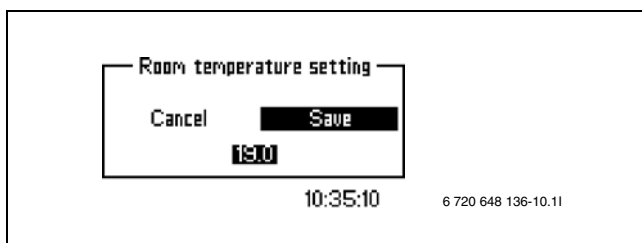

Fig. 9

Under **Advanced** you can also set how much you want the room controller to affect the heating system (→ Chapter 10.2.2). This is carried out in the same way for mixed heating circuit.



Wait at least twenty-four hours when increasing or decreasing the heating before making a new adjustment.

### 9.5 EXTRA HOT WATER

With menu point **Extra hot water** the DHW temperature can be raised temporarily to 65 °C. In this case the heat pump is supported in raising the temperature by the additional electric heater or the additional heating appliance.

- ▶ Select **Extra hot water** in the menu.
- ▶ Set the number of hours that the function is to be active by twisting the menu dial. Turn the knob clockwise to increase and anticlockwise to reduce.
- ▶ Select **Save** to save the change or **Cancel** to return without saving.

## 10 ADVANCED MENU

Under **Advanced** there are extra functions that can be used to affect the heating unit.

### 10.1 OVERVIEW

Advanced menu	
Heating/cooling	Heating system temperature
	room sensor settings
	Time-limited settings
	Heating season
	Heating, maximum operating time at hot water demand
	Temperature heating system 2 <sup>1)</sup>
Hot water <sup>2)</sup>	Extra hot water
	Hot water peak
	Hot water temperature
	Time control hot water
Timers	Display active timer (timer programs)
Setting the clock	Set date
	Set time
Alarm	Alarm log
	Info log
Access level	
Return to factory settings	
Deactivate alarm buzzer	
Program version	

Table 3 Extended menu

1) Only if a second system is installed

2) Only if a heat pump DHW cylinder is installed

**10.2 HEATING**

In this chapter a more controlled way of making settings for heating is described than under the heading **Menu**.

**10.2.1 HEATING SYSTEM TEMPERATURE**



Adjusted at commissioning. Not normally adjusted by the customer.

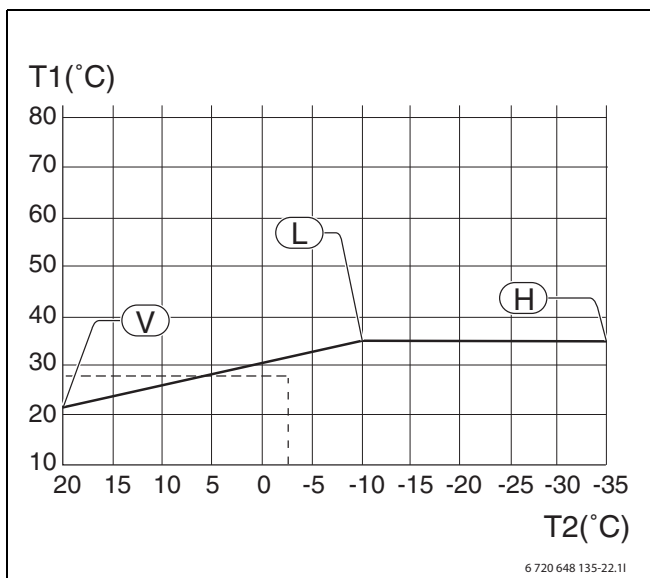

Fig. 10 Heating curve

- [T1] Flow temperature
- [T2] Outside temperature
- [1] Lowest outside temperature. At low temperatures the flow temperature remains unchanged.

The **heat curve** determines the relationship between the outdoor temperature (T2) and the flow temperature (T1). The left value of the heat curve (V), the right value of the heat curve (H), and the flow temperature (T1), can be adjusted for every fifth degree between them.



On delivery of the heat pump, the curve slope is set at V=20 and H=35.

Typical examples of V-values and H-values:

V = 22, H = 30: underfloor heating, concrete/screed slab

V = 22, H = 40: underfloor heating, wood joists

V = 20, H = 50: radiators



These values are only approximate. Your heating system should be designed in line with current MCS guide lines, taking into consideration a heat loss calculation of the property and correct heater emitter sizing. The installer should also hand over a comprehensive document pack about your heating system for use with this heat pump as per MCS.

The slope of the heat curve and the H-value depend on the setting of the lowest outdoor temperature (L), which is set by the installer.

A lower heat curve gives a lower flow temperature, which could result in greater energy savings.

Adjusting the heating curve:

- ▶ Select menu option **Heat curve Heating system temperature**.

- ▶ Using the rotary selector, choose the value (H or V) which you want to change.
- ▶ Press the rotary selector once to mark the selected value.

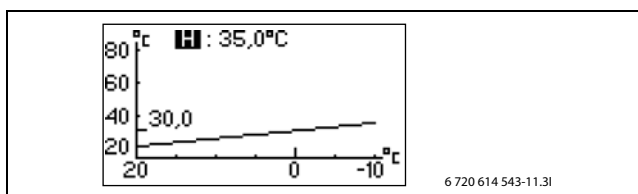

Fig. 11

- ▶ Turn the menu dial to change the selected value.
- ▶ Press the rotary selector once and select **Save**.

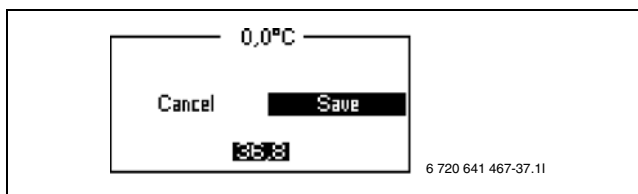

Fig. 12

Terminate menu point **Heat curve**:

- ▶ Turn the menu dial until the highlighted return arrow is displayed.

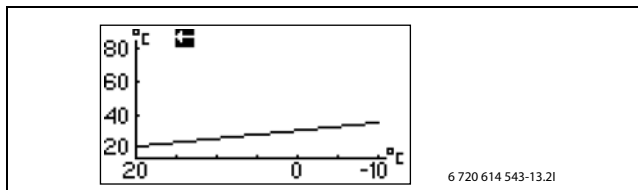

Fig. 13

- ▶ Press the rotary selector.

**10.2.2 ROOM SENSOR SETTINGS (ROOM CONTROLLER)**

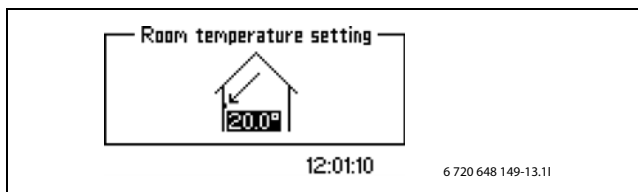

Fig. 14

To set the required room temperature:

- ▶ Select menu option **Room temperature setting**.
- ▶ Setting the required room temperature. Minimum = +10°C, maximum = +35°C.
- ▶ Choose **Save** to save changes. Or choose **Cancel** to ignore changes without saving.

**Room sensor influence** means that the influence of the sensor on the heating system can be adjusted.

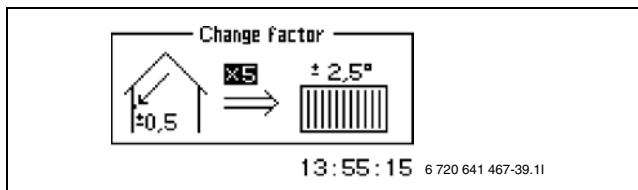

Fig. 15

Raise or lower the change factor to set the influence of the room temperature sensor on the heating system.

- ▶ Select menu option **Room sensor influence**.
- ▶ Select **Change factor** in the submenu.
- ▶ Specify the required value using the rotary selector. Minimum = 0, maximum = 10.



- ▶ Press the rotary selector once and select **Save**.

**Blocking time** means that the influence of the room controller on the heating system is blocked for a set time for a lower heating temperature period, to give the heat pump the opportunity to raise the room temperature at a slower rate.

- ▶ Select menu option **Room sensor influence**.
- ▶ Select **Blocking time** in the submenu.
- ▶ Specify the required value using the rotary selector. Minimum = 0, maximum = 24h.
- ▶ Press the rotary selector once and select **Save**.

### 10.2.3 TIME LIMITED SETTINGS

**Time control heating** enables you to increase or decrease the temperature on different days of the week for customised times. This function can for example be used to lower the temperature at night.



Timer control is not recommended in normal conditions as it can impact on energy consumption. It usually takes a long time for a temperature change to take effect due to the inertia of the house.

- ▶ Select menu option **Time control heating**.
- ▶ Select the **Day and time**.
- ▶ Enter day and time.
- ▶ Select **On**.
- ▶ Select the **Save**.
- ▶ Select **Change in temperature** and select the required value. Minimum = -20°C, maximum = +20°C.
- ▶ Select **Save** to save the change or **Cancel** to return without saving.

Reset time control:

- ▶ Reset the current time control as described above.
- ▶ Select **Off**.

Reset time control:

- ▶ Reset the current time control as described above.
- ▶ Select **Off**.

**Holiday** allows the possibility of decreasing (or increasing) the temperature between two set dates.

- ▶ Select menu option **Holiday**.
- ▶ Select the start and end date in the format YY/MM/DD.
- ▶ Select the **Save**.
- ▶ Select **Change in temperature** and select the required value. Minimum = -20°C, maximum = +20°C.

End function:

- ▶ Select the **Holiday**.
- ▶ Change the end date to one day *before* the start date.

### 10.2.4 HEATING SEASON

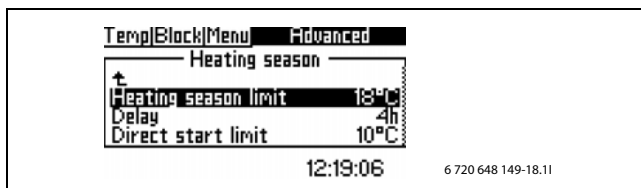

Fig. 16

The heat pump and the additional heater produce heat only when the outdoor temperature falls below the adjustable value **Heating season limit**.

- ▶ Select menu option **Heating season limit**.
- ▶ Set the required value. Minimum = +10°C, maximum = +35°C.
- ▶ Select **Save** to save the change or **Cancel** to return without saving.

To avoid lots of starts and stops of the heat pump when the outdoor temperature lies close to the limit value, the activity of this function is delayed with the adjustable value **Delay**.

- ▶ Select menu option **Delay**.
- ▶ Set the required value. Minimum = 1 hour, maximum = 24 hours.
- ▶ Select **Save** to save the change or **Cancel** to return without saving.

**Direct start limit** means that the delay is set aside and heat production starts immediately if the temperature drops below the set value.

- ▶ Select menu option **Direct start limit**.
- ▶ Set the required value. Minimum = +5°C, maximum = +35°C.
- ▶ Select **Save** to save the change or **Cancel** to return without saving.

### 10.2.5 HEATING, MAXIMUM OPERATING TIME AT HOT WATER DEMAND

This function ensures the hot water requirement during heat production. The time is adjustable between 0 and 60 minutes.

### 10.2.6 TEMPERATURE HEATING SYSTEM 2

Is only displayed if a mixer module was installed.

- ▶ Do the same settings as for heating system 1 (→ chapter 10.2.1- 10.2.4).

## 10.3 HOT WATER

The menus for hot water settings are used to make changes to hot water operation and are only displayed when a hot water heater is installed.

### 10.3.1 EXTRA HOT WATER

The function **Extra hot water** is used to temporarily raise the temperature of the hot water to circa 65°C. The heat pump then has help from the additional heater or boiler to raise the temperature.

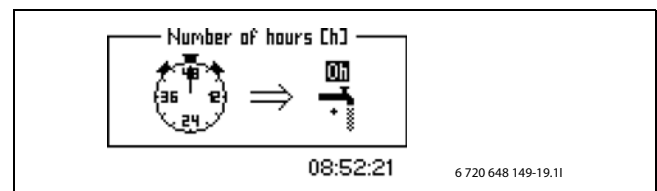

Fig. 17

- ▶ Select menu option **Extra hot water**.
- ▶ Select **Number of hours**.
- ▶ Set the duration of the function by choosing the number of hours. Minimum = 0, maximum = 48 hrs.
- ▶ Select **Save** to save the change or **Cancel** to return without saving. If **Save** is selected the function starts immediately.

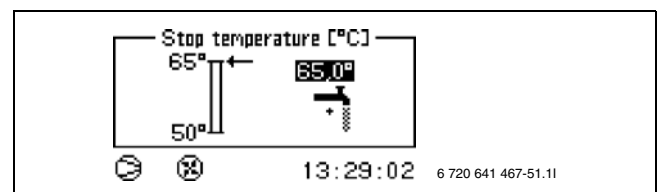

Fig. 18

The maximum temperature for the domestic hot water is set in the extra DHW mode in **Stop temperature**.

- ▶ Select menu option **Stop temperature**.
- ▶ Set the required stop temperature. Minimum = 50°C, maximum = 65°C.
- ▶ Select **Save** to save the change or **Cancel** to return without saving.

To see the remaining length of time of **Extra hot water**, go to the menu **Timers**.

### 10.3.2 HOT WATER PEAK DHW (ANTI LEGIONELLA)

Pasteurisation is set in **Hot water peak**. If you set the interval to 7 days, for example then the DHW temperature is raised to approx. 65 °C every seventh day.

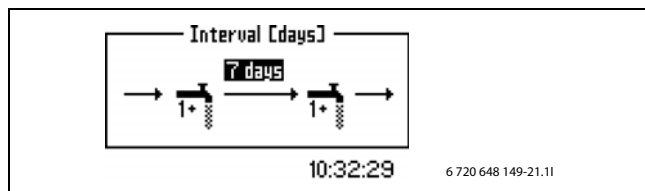

Fig. 19

- ▶ Select menu option **Hot water peak**.
  - ▶ Select **Interval**.
  - ▶ Set required interval. Minimum = 0, maximum = 28 days.
  - ▶ Select **Save** to save the change or **Cancel** to return without saving.
- With **Start time** you determine when pasteurisation should commence.

### 10.3.3 HOT WATER TEMPERATURE

**Hot water, maximum operating time at heating demand** is used for setting the maximum operating time for DHW when heat is required.

- ▶ Select the **Hot water temperature**.
- ▶ Select the **Hot water, maximum operating time at heating demand**.
- ▶ Set the duration of the function by choosing the number of hours. Minimum = 0, maximum = 60 minutes.
- ▶ Select **Save** to save the change or **Cancel** to return without saving.

### 10.3.4 TIME CONTROL HOT WATER

**Time control hot water** is used to disable hot water heating completely to save energy. This is primarily effective when peak tariffs (high price for energy consumption) are charged, but also gives limited access to hot water. This is done in the same way as with the other heat pump time controls.

### 10.3.5 TIME CONTROL HOT WATER CIRCULATION



This function is only used when a secondary hot water circulation pump is installed.

The time control for the DHW circulation pump is set under **Advanced**.

- ▶ Under **Advanced**.
- ▶ Select **Hot water**.
- ▶ Select **Time control hot water**.

A switch-on and switch-off can be set for each day of the week.

### 10.4 TIMERS



Fig. 20

The controller has several time programs. The status of the time programs is displayed in the **Timers** menu. Only activated functions are displayed in the menu. The others are hidden until activation.

### EXTRA HOT WATER

Displays the remaining time for requested extra hot water.

### ADDITIONAL HEAT START

Displays the countdown of the timer for delay of additional heat.

### MIXING VALVE CONTROL DELAY

Displays the time that the mixing valve function is delayed after the additional heat timer has counted down.

### ALARM MODE DELAY

Displays the remaining time until the additional heat is activated when an alarm is triggered.

### COMPRESSOR START

Displays remaining time of compressor start delay.

### HEATING, OPERATING TIME AT HOT WATER DEMAND

Displays the remaining time before the maximum time in heating mode is reached if there is a simultaneous hot water requirement.

### HOT WATER, OPERATING TIME AT HEATING SYSTEM DEMAND

Displays the remaining time before the maximum time for hot water production is reached if there is a simultaneous heating requirement.

## 10.5 SETTING THE CLOCK

The heat pump has functions that are dependent on both the time and date. Thus it is important that these are correct.

### 10.5.1 SET DATE

Setting the date:

- ▶ Select **Setting the clock** in the extended menu.

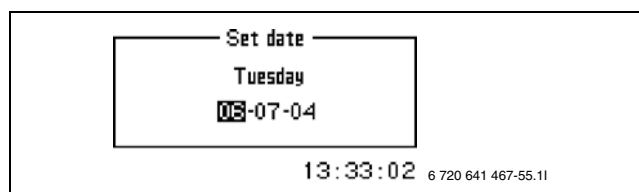

Fig. 21

- ▶ Select the **Set date**.
- ▶ Set the correct date with the menu dial. Use the form Year-Month-Day (yy/mm/dd).
- ▶ Select **Save** to save the change or **Cancel** to return without saving.

### 10.5.2 SET TIME

Set the time:

- ▶ Select **Setting the clock** in the extended menu.

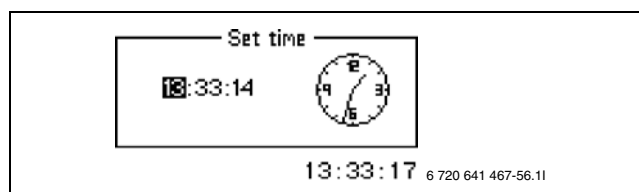

Fig. 22

- ▶ Select the **Set time**.
- ▶ Set the correct time with the menu dial. Use the form Hour:Minute:Second.
- ▶ Select **Save** to save the change or **Cancel** to return without saving.

### 10.6 ALARM

Any triggered alarms and warning displays are stored, together with the time of their occurrence, in **Alarm log**. If an alarm symbol is shown on the display, the alarm is still active and steps are required accordingly. (→chapter 13).

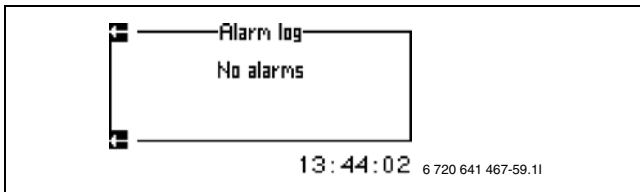

Fig. 23

Call up **Alarm log**:

- ▶ Select **Alarm**.
- ▶ Select **Alarm log**.

The info icon (→ Fig. 4, [12]) is shown on the display if an event occurs which does not require immediate inspection but is stored in **Info log**. The icon is shown on the display until the text in the **information report** is read.

Call up **Info log**:

- ▶ Select **Alarm**.
- ▶ Select **Info log**.

### 10.7 ACCESS LEVEL

This menu is used by the installer and the service engineer. Standard is the customer level, Level = 0.

### 10.8 RETURN TO FACTORY SETTINGS

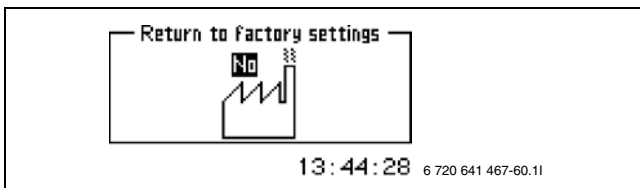

Fig. 24

Restore factory settings:

- ▶ Select the **Return to factory settings**.
- ▶ Select the **Yes**.
- ▶ Select **Save** to save the change or **Cancel** to return without saving.

This does not affect the settings made in the Installer/Service level.

### 10.9 DEACTIVATE ALARM BUZZER

When an alarm occurs, an alarm window is displayed and a warning signal sounds. This warning signal is turned off if the alarm is acknowledged or returned (→ Chapter 13).

Deactivate alarm buzzer:

- ▶ Select the **Deactivate alarm buzzer**.
- ▶ Select the **Yes**.
- ▶ Select **Save** to save the change or **Cancel** to return without saving.

### 10.10 PROGRAM VERSION

The program version of the control unit is displayed. It is useful to have this information on hand when contacting the installer.

## 11 LCD ROOM CONTROLLER (ACCESSORY)

- i** The room controller has the function to provide:
- ▶ Change room temperature setting
  - ▶ Shows the actual room temperature
  - ▶ Shows the outdoor temperature (if chose in the display)
  - ▶ Flashes when there is an alarm in the display

The control unit supports up to two room controllers, one for each heating circuit.

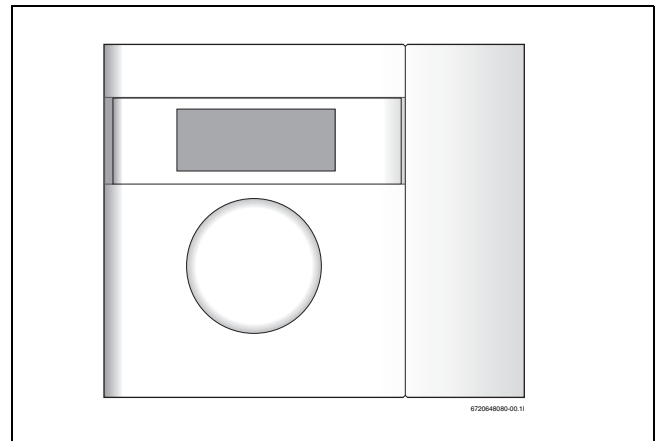

Fig. 25 CAN-BUS LCD room controller

### THE DISPLAY FUNCTIONS

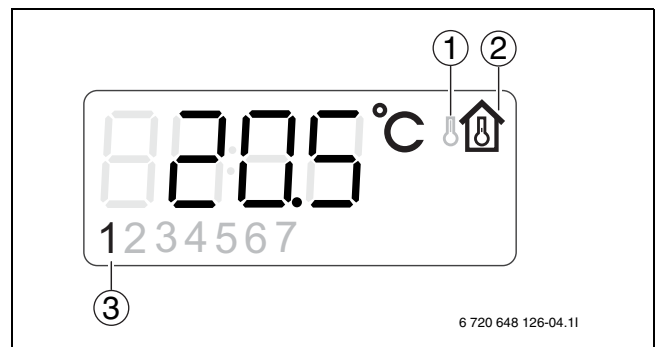

Fig. 26 Display

- [1] Outside temperature display
- [2] Room temperature display
- [3] Current heating circuit

The display window shows the current room temperature. When **Outdoor temperature display in room sensor** (room controller) is set to **Yes** the outdoor temperature is also shown, alternating with the room temperature. This is valid for all installed room controllers.

With certain categories of alarm, the alarm is displayed on the room temperature sensor display. In this case, the display slowly flashes red until the alarm is confirmed or automatically reset on the heat pump controller.

### SETTING THE ROOM TEMPERATURE WHEN A ROOM CONTROLLER HAS BEEN INSTALLED

The room temperature can easily be set using the room controller.

- ▶ Turn the room controller knob to set the desired room temperature for the circuit. The previous set value is shown with blinking digits. The display flashes the setting and stops flashing shortly after turning the dial has stopped. The value in the control unit menu **Room temperature setting** for the circuit is automatically set to the same value.

Alternatively the desired room temperature is set via the control panel.

- ▶ Go to the menu **Room temperature setting** for the circuit and set the desired room temperature. The room temperature value in the room controller for the circuit is automatically set to the same value.

With certain categories of alarm, the alarm is displayed on the room temperature sensor display. In this case, the display slowly flashes red until the alarm is confirmed or automatically reset on the heat pump controller.

## 12 MAINTENANCE

The heat pump requires a minimum of maintenance, however, some servicing is still required to get optimal performance from your heat pump. Check the following items a few times per year:

- Remove dirt and leaves from the outdoor collector using a water can with a rose attachment
- External casing
- Evaporator

 **DANGER:** The heat pump is connected to high currents.  
▶ Turn off the power supply before rectifying.

 **NOTICE:** Never use a pressure washer to clean the heat pump.

 Damage to system by cleaning agents and care products!  
▶ Do not use cleaning agents and care products that are abrasive or contain acid or chlorine.

### 12.1 REMOVE DIRT AND LEAVES

- ▶ Use a fine soft brush to remove the dirt and leaves from the heat pump.

### 12.2 PROTECTIVE COVERS

Over time dust and other dirt will collect on the heat pump.

- ▶ Clean the exterior, if necessary, with a damp cloth.
- ▶ Scratches and other damage on the casing should be touched up with anti-rust paint.
- ▶ The paint can be protected with a car wax.

### 12.3 EVAPORATOR

 The evaporator should be checked by a qualified engineer - usually as part of an annual service visit.

If a coating (for example dust or dirt) has built up on the surface of the evaporator (coil fins), it should be wiped off.

 **WARNING:** The thin aluminium fins are fragile and can be damaged if careless. Never wipe the delicate fins with a cloth.  
▶ Use protective gloves to protect your hands from cuts.  
▶ Do not use a too powerful water jet.

Clean the evaporator:

- ▶ Spray detergent onto the evaporator fins on the rear side of the heat pump.
- ▶ Wash off coating and cleaning agent with a watering can and rose attachment.

### 12.4 SNOW AND ICE

In some locations or during periods of snow, snow can accumulate inside the protective grille on the rear side.

- ▶ Carefully brush the snow off the fins.

To prevent icing, the heat pump is equipped with automatic defrosting. In the event of any problems, this may need adjusting. Contact your installer.

### 12.5 MOISTURE

 **NOTICE:** If moisture is found underneath the Hydrolight or Hydrocomfort unit, contact the installer.  
▶ Switch off the heat pump and contact the installer if moisture appears around any of the heating system components.

### 12.6 LEAKAGE TESTS

In accordance with current EU legislation (the F-gas regulation, EC Regulation No 842/2006 which came into effect on 4 July 2006), a heat pump that contains more than 3 kg of refrigerant R410A must be checked regularly by an accredited installer.

Leak tests must be performed at installation and then repeated every 12 months.

- ▶ Contact your installer.

### 12.7 CHECKING THE SAFETY VALVES

 The safety valve should be checked by a qualified engineer - usually as part of an annual service visit.

 Never close the safety valve or obstruct its discharge pipe.

- ▶ Check that the waste water hose from the safety valve is not blocked.

### 12.8 FILTER

 The filter is installed in the return heating pipe to the Hydrolight/Hydrocomfort.

The filter prevents particles and dirt from entering the interior of the heat exchanger. Over time, the filter can become blocked and must be cleaned regularly. It is also recommended that the heating system is power washed prior to the installation of the heat pump and that a dirt filter is also fitted.

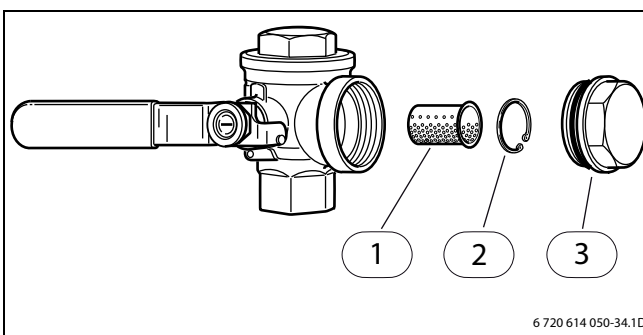

Fig. 27

- [1] Filter
- [2] Circlip
- [3] Plug

Cleaning the filter:

- ▶ Switch off the heat pump with the ON/OFF switch.
- ▶ Close the valve and remove the plug.

- ▶ Remove the locking ring which retains the filter inside the valve. Use the pliers provided.
- ▶ Remove the filter from the valve and flush the filter with water.
- ▶ Reinstall the filter, circlip and plug.
- ▶ Open the valve and start the heat pump via the ON/OFF switch.



Ensure that the heating circuit is free from air at all times, i.e radiators or underfloor circuits.

## 13 ERROR MANAGEMENT

The control panel has an advanced monitoring system that gives alarms if anything unforeseen happens. The user can rectify most of these alarms themselves. There is never a risk of affecting something when an alarm is reset once or twice. Contact the installer engineer in the event of repeated alarms.

In the menu **Alarm** there is:

- **Alarm log**
- **Info log**

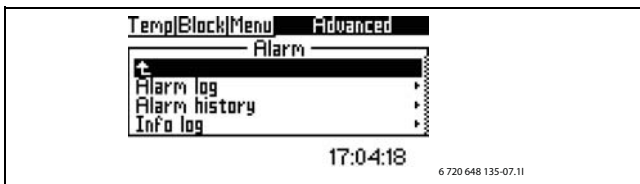

Fig. 28

The customer level = 0 gives access to alarm information in the **Alarm log**.

Installer/Service level = 1 gives access to:

- **Delete alarm log**
- Information regarding the **Alarm history**.
- Information regarding the **Info log**.
- **Delete info log**

### 13.1 ALARM LOG AND INFO LOG

In the **Alarm log** and the **Info log**, all alarms and warnings that have occurred are stored in chronological order.

- ▶ Delete the **Alarm log** and the **Info log** after commissioning is complete.

### 13.2 EXAMPLE OF AN ALARM:

When an alarm is triggered, an alarm window is displayed and a warning signal sounds. The alarm window displays the alarm causes and the time and date that the alarm occurred.

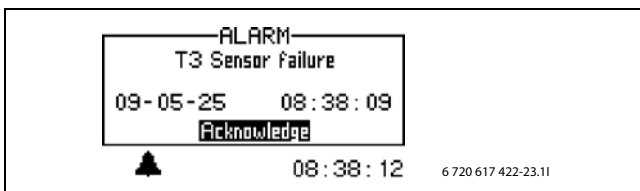

Fig. 29

If you press the rotary selector, **Acknowledge** is marked, the alarm symbol disappears and the warning signal is suppressed. The heat pump restarts if heat demand exists.

The alarm symbol continues to be displayed if a fault is not remedied. The ON and fault indicators change from flashing red to constant red indications. Every alarm is stored in the alarm log. Active alarms are indicated by the alarm symbol.

The alarm symbol appears for both alarms in the heat pump and for alarms in the Hydrolight/Hydrocomfort unit, if alarms have occurred in both the units, two alarm symbols will appear.

### 13.3 BLANK MENU DISPLAY

#### 13.3.1 POSSIBLE CAUSE 1: FAULTY FUSE IN THE DOMESTIC POWER SUPPLY.

- ▶ Check whether all domestic fuses are OK.
- ▶ If required, change/reset fuse/MCB. See installation manual for details on fuse type.

After the fault has been remedied, the heat pump automatically restarts.

#### 13.3.2 POSSIBLE CAUSE 2: THE MINIATURE CIRCUIT BREAKER IN THE HYDROLIGHT/HYDROCOMFORT UNIT HAS TRIPPED.

- ▶ Contact the installer.

### 13.4 ALL ALARMS, WARNINGS AND INFORMATION WINDOWS

An alarm can occur temporarily due to various reasons. However, there is never a risk involved in resetting an alarm. All the alarms that can appear in the menu display are described in this section. The descriptions give an idea about the nature of the alarm and what can be done to rectify it.

The alarm log shows alarms and warnings that have occurred.

### 13.5 ALARM WINDOW

#### 13.5.1 FAILURE / SHORT CIRCUIT ON SENSOR

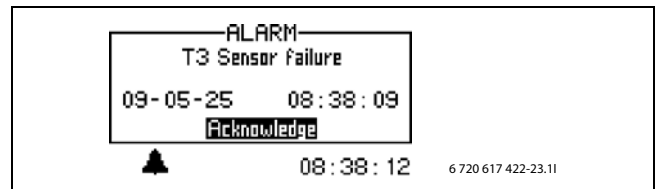

Fig. 30

All sensors connected to the heating installation can give an alarm in the event of a fault. In the example, it is sensor T3, hot water, which has given an alarm. All sensors give alarms in the same way.

#### Possible cause 1: occasional fault.

- ▶ Confirm alarm and continue monitoring.

#### Possible cause 2: fault at temperature sensor or incorrect connection.

- ▶ Contact the installer in the event of repeated alarms.

#### 13.5.2 MAX FLOW TEMPERATURE, HEATING SYSTEM OR MAX FLOW TEMPERATURE, MIXED HEATING SYSTEM

The flow temperature has reached the max. allowable temperature.

- ▶ Select **Acknowledge**.
- ▶ Contact the installer in the event of repeated alarms.

#### 13.5.3 T8 HIGH FLOW TEMPERATURE OR T71 HIGH FLOW TEMPERATURE

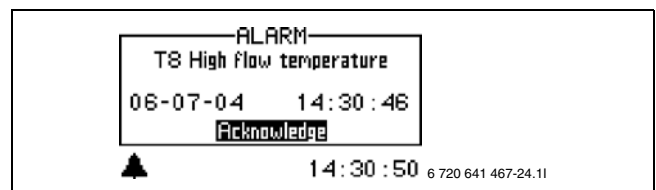

Fig. 31

There are two sensors, T8 and T71, in the Hydrolight/Hydrocomfort unit, which for safety reasons stop the heat pump if the temperature of the flow rises above the set value.

**PROBABLE CAUSE 1; INSUFFICIENT FLOW OVER THE HEAT PUMP:**

- ▶ Select **Acknowledge**.
- ▶ Check that all the valves are open. The thermostat valves in heating systems should be fully open and in floor heating systems at least half of the coils should be fully open.
- ▶ Contact the installer in the event of repeated alarms.

**POSSIBLE CAUSE 2; BLOCKED PARTICLE FILTER:**

- ▶ Select **Acknowledge**.
- ▶ Contact the installer in the event of repeated alarms.

**13.5.4 ERROR IN MAIN BOARD, HEATING SYSTEM**

An error has occurred in the communication between the Hydrolight/Hydrocomfort module and the heat pump.

- ▶ Contact the installer in the event of repeated alarms.

**13.5.5 ERROR IN ACCESSORY BOARD**

Fault in the accessories board (IOB-B) in the Hydrolight/Hydrocomfort module or corresponding communication.

- ▶ Select **Acknowledge**.
- ▶ Contact the installer in the event of repeated alarms.

**13.5.6 ERROR IN ROOM SENSOR BOARD (ROOM CONTROLLER) OR ERROR IN E12.T5 ROOM SENSOR BOARD**

Fault in the CAN-BUS connected room controller or communication to it.

- ▶ Select **Acknowledge**.
- ▶ Contact the installer in the event of repeated alarms.

**13.5.7 ERROR IN MULTI FUNCTION BOARD**

Fault in the multifunction board or corresponding communication.

- ▶ Select **Acknowledge**.
- ▶ Contact the installer in the event of repeated alarms.

**13.5.8 FAULT ON ADDITIONAL HEATER**

Alarm from additional electric heater.

- ▶ Check status in the booster heating.
- ▶ Select **Acknowledge**.
- ▶ Contact the installer in the event of repeated alarms.

**13.5.9 FREEZE PROTECTION EXCHANGER T9 ACTIVATED**

An error has occurred with the frost protection for the exchanger.

- ▶ Select **Acknowledge**.
- ▶ Contact the installer in the event of repeated alarms.

**13.5.10 ALARM HEAT PUMP**

The heat pump has developed a fault.

- ▶ Select **Acknowledge**.
- ▶ Contact the installer in the event of repeated alarms.

**13.5.11 LOW MAINS VOLTAGE**

If the mains voltage falls below 170 V, the information symbol in the display lights up. If the voltage falls below 170 V for more than one hour, the alarm is activated.

- ▶ Contact the installer.

**13.5.12 OR SAFETY THERMOSTAT VS2 TRIPPED**

- ▶ **Acknowledge** Thermostat with alarm
- ▶ Contact the installer in the event of repeated alarms.

**13.5.13 SCREED DRYING SET POINT VALUE FOR HEATING NOT REACHED**

The alarm is activated if the temperature at the current stage in the drying program is not reached within the set time.

**13.5.14 OVERLOADED TRANSFORMER**

- ▶ Select **Acknowledge**.
- ▶ Contact the installer in the event of repeated alarms.

**13.5.15 FAULT ON ELECTRIC ELEMENT**

Fig. 32

**Possible cause 1: overheating protection of the power supply has tripped.**

- ▶ Check that the heat carrier pump has not stopped.
- ▶ Reset overheating protection of power supply. A reset button is located in the switch box of the Hydrolight/Hydrocomfort module.
- ▶ Select **Acknowledge**.
- ▶ Contact the installer in the event of repeated alarms.

**13.5.16 NO PRESSURE IN SYSTEM**

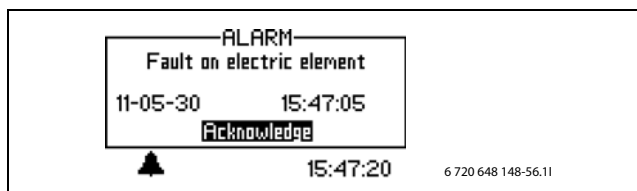
If the system pressure is less than 0.5 bar (Hydrocomfort only), this trips the pressure switch which switches off the power supply and triggers the alarm **No pressure in system**. To remedy the fault:

- ▶ Check that the expansion tank and safety valve are suited for the correct pressure in the system.
- ▶ Slowly increase the pressure in the heat system by adding water via the filling valve.
- ▶ Acknowledge the alarm manually by pressing the rotary selector in the user interface of the Hydrocomfort unit (→, fig. 2).

**13.6 WARNING MESSAGE**
**13.6.1 IS THE HEAT PUMP FUSED FOR THIS OUTPUT?**

The warning is activated to ensure that the system is designed to handle the load produced.

In the info log is stored **Check fuse**.

- ▶ Check that the heat pump and the Hydrolight/Hydrocomfort unit is connected to the correct fuse size.

**13.6.2 MAXIMUM WORKING TEMPERATURE HEAT PUMP**

In the info log is stored **Maximum working temperature heat pump**.

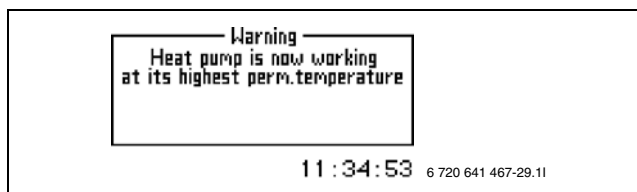

Fig. 33

The temperature sensor T9 located in the Hydrolight/Hydrocomfort unit stops the heat pump for safety reasons as soon as the temperature of the return water exceeds a certain limit (>56 °C).

**Probable cause 1; The heat setting is set so high that the heating system's return temperature is too high:**

- ▶ Reduce the heat setting.

**Possible cause 2: valves on the underfloor heating system or radiators are closed.**

- ▶ Open the valves.

### 13.6.3 HIGH TEMPERATURE DIFFERENCE HEAT TRANSFER FLUID

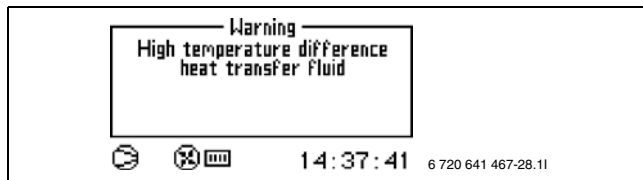

Fig. 34

This warning window is displayed when the temperature difference between sensors T8 and T9 becomes too high.

#### PROBABLE CAUSE 1; BLOCKED PARTICLE FILTER:

- ▶ Clean filter (→chapter 12.8)
- ▶ Select **Acknowledge**.
- ▶ Contact the installer in the event of repeated warnings.

#### POSSIBLE CAUSE 2: INADEQUATE FLOW RATE ACROSS THE HYDROLIGHT/HYDROCOMFORT UNIT.

- ▶ Select **Acknowledge**.
- ▶ Check that all the valves are open. The thermostat valves in heating systems should be fully open and in floor heating systems at least half of the coils should be fully open.
- ▶ Contact the installer in the event of repeated warnings.

### 13.6.4 TOO SHORT CHANGEOVER TIME FOR FLOOR HEATING

In the info log is stored **Too short changeover time for floor heating**.

The warning appears if the value **Delay before** is set to a shorter time than 7 hours or the value **Delay after** is set shorter than 7 hours, which is not recommended during underfloor heating.

## 13.7 INFORMATION WINDOW

### 13.7.1 LOW MAINS VOLTAGE

If the mains voltage falls below 170 V, the information symbol in the display lights up. If the mains voltage is below 170 V for one hour, an alarm is triggered.

- ▶ Contact the installer in the event of repeated warnings.

## 13.8 INFO SYMBOL

For a number of events that occur when the heat pump is in operation, an icon appears in the display without an alarm being triggered. Although these events do not require immediate action, they are saved in the information report.

Once the text in the information report has been read the icon vanishes from the display.

### 13.8.1 HEAT PUMP OPERATING TEMPERATURES

If the outdoor temperature exceeds 46 °C in 30 minutes, the Info icon is activated. The booster heater takes over operation of the system. Confirmation is given if the temperature once again falls below 46 °C.

If the outdoor temperature falls below the set value in **Block heat pump at low outdoor temperature** (factory value = - 15 °C) the heat pump stops. The warning is activated and the heating installation switches to operating with only additional heat.

### 13.8.2 MAXIMUM FLOW TEMPERATURE, HEAT PUMP

The temperature in the system has reached the maximum temperature for the heat pump.

#### Possible cause 1: heating curve set too high

- ▶ Adjust the heating curve (→ chapter 10.2).

#### Possible cause 2; error in the mains system

- ▶ Check filters and valves.

### 13.8.3 MAXIMUM FLOW TEMPERATURE, ADDITIONAL HEAT

The CH flow has now reached its max. temperature.

#### Possible cause 1: heating curve set too high

- ▶ Adjust the heating curve (→ chapter 10.2).

#### Possible cause 2; error in the mains system

- ▶ Check filters and valves.

### 13.8.4 MAXIMUM WORKING TEMPERATURE ADDITIONAL HEAT

The CH return has reached the max. permissible temperature. Possible cause: heating curve set too high.

#### Possible cause 1: heating curve set too high

- ▶ Adjust the heating curve (→ chapter 10.2).

#### Possible cause 2; bivalence point set incorrectly.

- ▶ Consult the installer if this occurs more than once.

### 13.8.5 TOO LOW FLOW TEMPERATURE OR TOO LOW FLOW TEMPERATURE, HEATING SYSTEM 2

If the temperature of the flow falls below the set point value longer than 15 minutes, the heat pump shuts down and the warning is activated.

## 14 FACTORY SETTINGS



Cooling function is not available in this product, so any reference to this in the menus can be disregarded.

### 14.1 FACTORY SETTINGS

The tables show the values which have been preset at the factory (F value). These values can be modified by the user = [0] via user levels **Menu** and **Advanced**.

The installer can access the items in the installation and service menu = [1] listed in the following table after changing the access level under **Menu** or **Advanced menu**. Only the items which are identified with a [0] are accessible to the user.

Menu	Level	F value
<b>Fast restart of heat pump</b>	1	No
Start up		
__\Setting the clock		
__\__\Set date	1	yy-mm-dd
__\__\Set time	1	hh:mm:ss
__\T1 maximum set point value	1	45 °C
__\External input		
__\__\Activated if	1	Closed
__\__\Change in temperature	1	0 °C
__\__\Stop hot water loading	1	No
__\__\Stop heating production	1	No
__\__\Additional heat only	1	No
__\__\Limit electrical capacity to	1	3/3
__\__\External blocking	1	No
__\__\Safety thermostat	1	No
__\__\Stop additional heat hot water	1	No
__\__\Stop additional heat radiators	1	No
__\Lowest outdoor temperature	1	-10 °C
__\Accessory board function	1	No
__\Max limit E12.T1 Set point value	1	45 °C
__\Connected extra sensors		
__\__\T3 acknowledged	1	Yes
__\__\T5 acknowledged (T5)	1	Yes
__\Manual operation	1	No
__\Operating mode, additional heater		
__\__\Additional heat only	1	No
__\__\Block additional heat	1	No
__\Correct sensor	1	0
__\Anti-jamming mode time	1	02:00
__\Alarm buzzer interval	1	1 min
__\Display		
__\__\Contrast	0	27
__\__\Brightness	0	100
__\System pressure sensor connected	1	Yes
__\Operation alternative G2	1	Continuous
<b>Room temperature setting (T5)</b>	0	20 °C
<b>Room temperature setting, heating system 2</b>	0	20 °C
<b>Extra hot water</b>	0	0 h

Table 4 Menu

Advanced menu	Level	F value
<b>Heating/cooling</b>		
__\Minimum outdoor temperature of heat curve	1	-10 °C
__\Heating system temperature		
__\__\Heat curve	0	V=20.0 °C H=35.0 °C
__\__\Hysteresis		
__\__\__\Quick acceleration	1	5.0 °C
__\__\__\Quick brake	1	1.0 °C
__\__\__\Quick stop	1	10.0 °C
__\__\__\Integration time	1	60°min
__\__\__\Rad brake temp increase	1	1.0 °C
__\__\__\Rad brake time	1	0 min
__\Room sensor setting		
__\__\Room temperature setting	0	20 °C
__\__\Room sensor interval	0	3K
__\__\Room sensor influence		
__\__\__\Change factor	0	2.0
__\__\__\Blocking time	0	4 hrs
__\Time limited settings		
__\__\Time control heating		
__\__\__\Day and time	0	Off
__\__\__\Change in temperature	0	-10 °C
__\__\Holiday		
__\__\__\Date	0	Off
__\__\__\Change in temperature	0	-10 °C
__\__\External input		
__\__\__\Activated if	1	Closed
__\__\__\Change in temperature	0	0 °C
__\Heating season		
__\__\Heating season limit	0	18 °C
__\__\Delay	0	4 hrs
__\__\Direct start limit	0	10 °C
__\Heating, maximum operating time at hot water demand	0	20 min
__\Shut down protection, change over hot water to heating	1	300 s
__\Maximum speed compressor	1	7
__\Quick acceleration time	1	15 min
__\Quick brake time	1	5 min

Table 5 Advanced menu

Advanced menu	Level	F value
__\Temperature heating system 2		
__\__\Heat curve	0	V=20.0 °C H=35.0 °C
__\__\Room sensor settings		
__\__\__\Room temperature setting	0	20 °C
__\__\__\Room sensor influence		
__\__\__\__\Change factor	0	5,0
__\__\__\__\Blocking time	0	4 hrs
__\__\Time limited settings		
__\__\__\Time control heating		
__\__\__\__\Day and time	0	Off
__\__\__\__\Change in temperature	0	-10 °C

Table 6 Advanced menu



Advanced menu	Level	F value
" " " \Holiday		
" " " " " \Date	0	Off
" " " " " \Change in temperature	0	-10 °C
" " " " \External input		
" " " " \Active if	1	Closed
" " " " \Change in temperature	0	0 °C
" " " \Mixing valve settings		
" " " " \Control unit reading	1	
" " " " \P-constant	1	1
" " " " \I-time	1	300s
" " " " \D-time	1	0.0s
" " " " \Mixing valve running time	1	300s
" " " " \Mixing valve limitation defrost mode	1	5 min

Table 6 Advanced menu

Advanced menu	Level	F value
<b>Hot water (T3)</b>		
" \Extra hot water		
" " \Number of hours	0	0
" " \Stop temperature	0	65 °C
" \Hot water peak		
" " \Interval	0	0 day
" " \Start time	0	03:00
" \Hot water temperature		
" " \In compressor mode	1	
" " " " \T3 Start temperature	1	46 °C
" " " " \T9 Stop temperature	1	47 °C
" " " \Hot water, max operating time at heating demand	0	30 min
" " \Time control hot water	0	Off
" \Slowest speed at hot water production	1	3
" \Max speed during hot water production	1	7
" \Quick start of addition	1	0 °C

Table 7 Advanced menu

Advanced menu	Level	F value
<b>Temperatures</b>		
" \Correct sensor	1	0,0 °C
" \Inputs	1	
" \Outputs	1	
" \Demand	1	
<b>Timers</b>		

Table 8 Advanced menu

Advanced menu	Level	F value
<b>Additional heat settings</b>		
" \Start delay	1	60 min
" \Time control additional heat	1	Off
" \Operating option		
" " \Additional heat only	1	No
" " \Block additional heat	1	No
" \Electric additional heat settings		
" " \Connection capacity		
" " " \State total output	1	9.0 kW
" " " \Compressor mode, output limitation	1	2/3
" " " \Additional heat only, output limitation	1	3/3
" " \Stop temperature T3	1	60 °C
" " \Ramp time increase	1	20 min
" " \Ramp time decrease	1	10 min
" " \Locking of electricity supply when defrosting	1	5 min
" " \Neutral zone	1	5 °C
" \Mixing valve settings		
" " \Mixing valve delay	1	20 min
" " " \PID heat setting		
" " " " \P constant	1	2.0
" " " " \I time	1	300 s
" " " " \D time	1	0
" " " " \PID hot water setting		
" " " " \P constant	1	4.0
" " " " \I time	1	300 s
" " " " \D time	1	0
Mixing valve's run time	1	120 s
Locking of mixing valve during defrosting	1	5 min
" " \Max outdoor temperature for additional heat	1	10 °C

Table 9 Advanced menu

Extended menu	Level	Fact. setting
<b>Safety functions</b>		
" \Block heat pump at low outdoor temperature	1	- 15 °C
" \Heating cable time	1	15 min
<b>Setting the clock</b>		
Setting the date	0	JJ-MM-TT
Setting the time	0	hh:mm:ss
<b>Alarm</b>		
" \Alarm log		
" " \Delete alarm log	1	No
" \Alarm history		
" \Info log		
" " \Delete info log	1	No
<b>Access level</b>	0, 1	K(0)
<b>Return to factory settings</b>	0, 1	B
<b>Deactivate alarm buzzer</b>	0	No

Table 10 Extended menu

## **15 THE GUARANTEE**

The Greensource Air to Water split heat pump has a 2 year guarantee against faulty material or manufacture subject to Terms and conditions. To read the full Terms and Conditions please visit us online at [www.worcester-bosch.co.uk/guarantee](http://www.worcester-bosch.co.uk/guarantee). The Guarantee Registration form is available on this same page and can be completed and submitted electronically. Alternatively please telephone one of our Guarantee Registration advisors on 0844 892 2552. Your statutory rights are not affected by the manufacturers guarantee.

## NOTES

Worcester, Bosch Group  
Cotswold Way, Warndon, Worcester WR4 9SW.  
Tel. 0844 892 9900

Worcester, Bosch Group is a brand name of Bosch Thermotechnology Ltd.  
[worcester-bosch.co.uk](http://worcester-bosch.co.uk)

6 720 806 630

**WORCESTER, BOSCH GROUP:**

TECHNICAL SUPPORT: 0844 892 3366  
APPOINTMENTS: 0844 892 3000  
SPARES: 01905 752571  
LITERATURE: 0844 892 9800  
TRAINING: 01905 752526  
SALES: 01905 752640

The logo for Worcester Bosch Group features a stylized, wavy graphic element on the left, composed of three overlapping, curved lines in shades of grey and black. To the right of this graphic, the word "WORCESTER" is written in a large, bold, black, sans-serif font. Below "WORCESTER", the words "Bosch Group" are written in a smaller, bold, black, sans-serif font.

**WORCESTER**  
**Bosch Group**