 The following labels and those like them are used to denote generic connections (such as the live supply to components) in order to simplify the diagram:  
**L** LIVE   **N** NEUTRAL   **E** EARTH

**Legend:**  
**L** = Live Supply  
**N** = Neutral Supply  
**LR** = Live Return  
**E** = Earth  
**C** = Common  
**S** = Satisfied  
**D** = Demand  
**M** = Motor  
**CH D** = Central Heating Demand  
**HW D** = Hot Water Demand

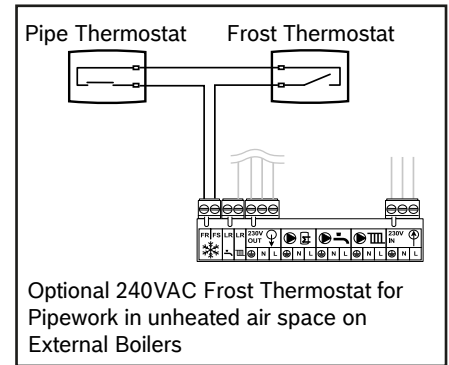

### Programmable Thermostat

The Link between the live (L) and common (C) may already be fitted as part of the programmable thermostat, if not then a link must be wired in.

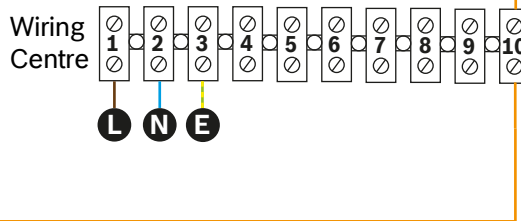
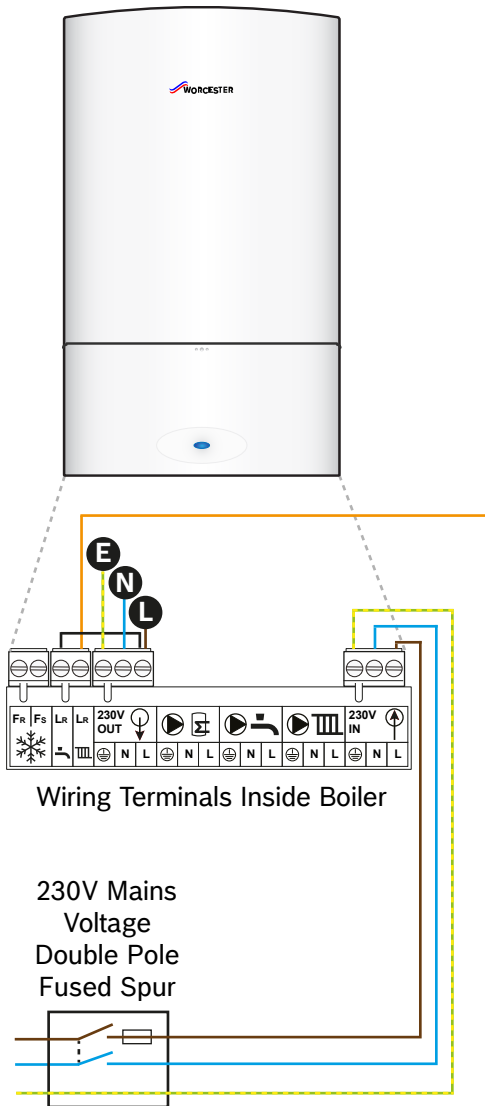
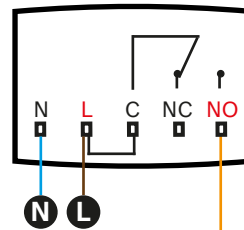

All electrical work should be carried out by a registered engineer. Wiring must comply with the latest IET wiring regulations. Isolate the mains electricity supply before starting any work and observe all relevant safety precautions. Refer to all relevant product installation manuals for safety and installation instructions. Whilst it is always our intention to fully assist, it is essential to recognise that all information given by the company is provided in good faith and based upon the information available. Connection labels may not match those of the products installed on site. We recommend that advice should always be checked with your installer, electrician or the manufacturer of the product in question. Consequently, the company cannot be held responsible for any liability relating to the use or repetition of such information or part thereof. In addition, whilst making every reasonable effort to monitor the performance and quality of our supply, installation and service network, we do not accept responsibility for the workmanship or operation of any third party company.

## Room Thermostat only

# 1H-R-R

 The following labels and those like them are used to denote generic connections (such as the live supply to components) in order to simplify the diagram:

**L** LIVE   **N** NEUTRAL   **E** EARTH

**Legend:**

- L** = Live Supply
- N** = Neutral Supply
- LR** = Live Return
- E** = Earth
- C** = Common
- S** = Satisfied
- D** = Demand
- M** = Motor
- CH D** = Central Heating Demand
- HW D** = Hot Water Demand

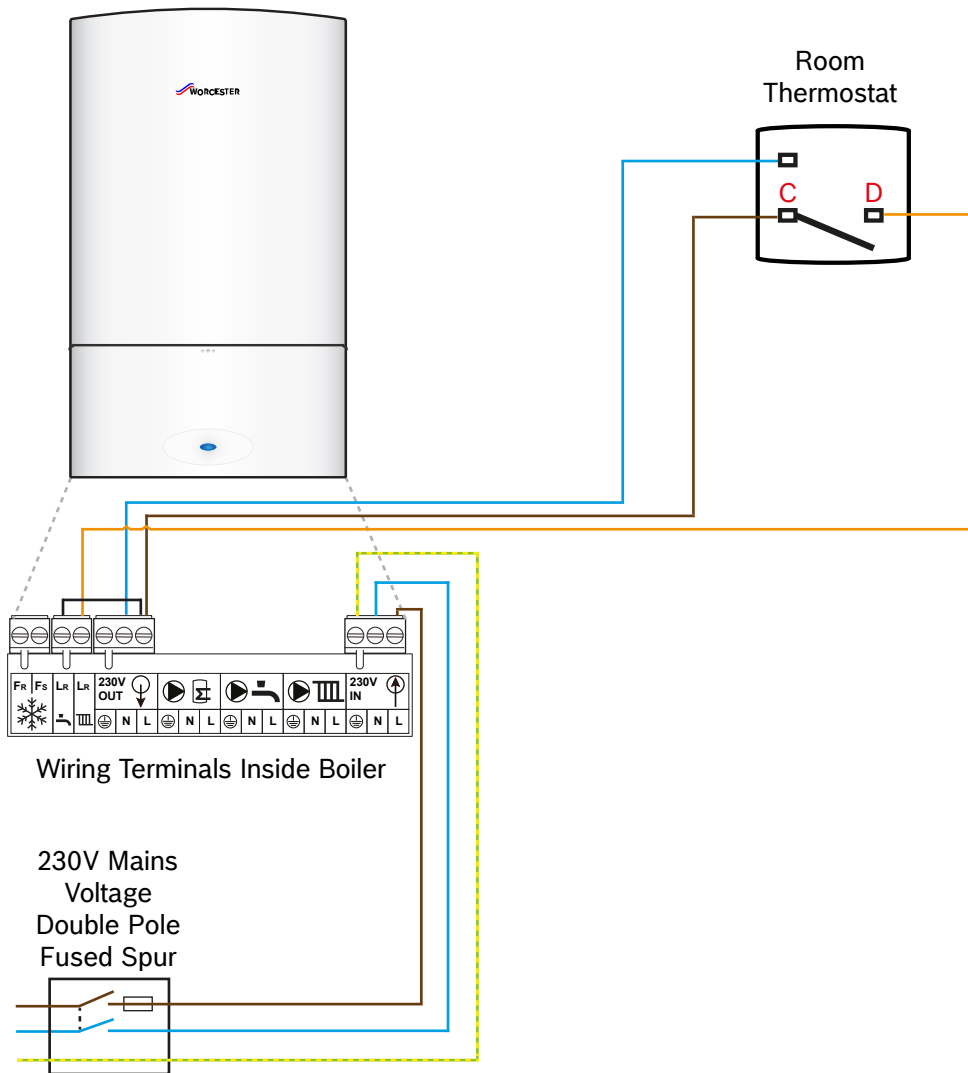
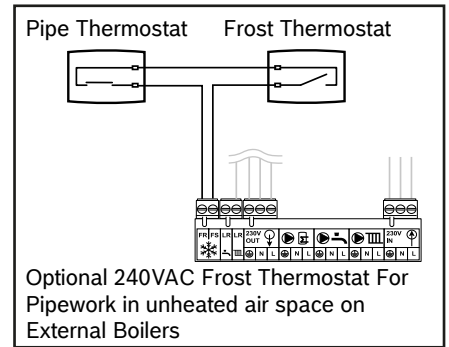

All electrical work should be carried out by a registered engineer. Wiring must comply with the latest IET wiring regulations. Isolate the mains electricity supply before starting any work and observe all relevant safety precautions. Refer to all relevant product installation manuals for safety and installation instructions. Whilst it is always our intention to fully assist, it is essential to recognise that all information given by the company is provided in good faith and based upon the information available. Connection labels may not match those of the products installed on site. We recommend that advice should always be checked with your installer, electrician or the manufacturer of the product in question. Consequently, the company cannot be held responsible for any liability relating to the use or repetition of such information or part thereof. In addition, whilst making every reasonable effort to monitor the performance and quality of our supply, installation and service network, we do not accept responsibility for the workmanship or operation of any third party company.

## 2 Heating Zones

## 2H-R-E

 The following labels and those like them are used to denote generic connections (such as the live supply to components) in order to simplify the diagram:

**L** LIVE   **N** NEUTRAL   **E** EARTH

**Legend:**

- L = Live Supply
- N = Neutral Supply
- LR = Live Return
- E = Earth
- C = Common
- S = Satisfied
- D = Demand
- M = Motor
- CH D = Central Heating Demand
- HW D = Hot Water Demand

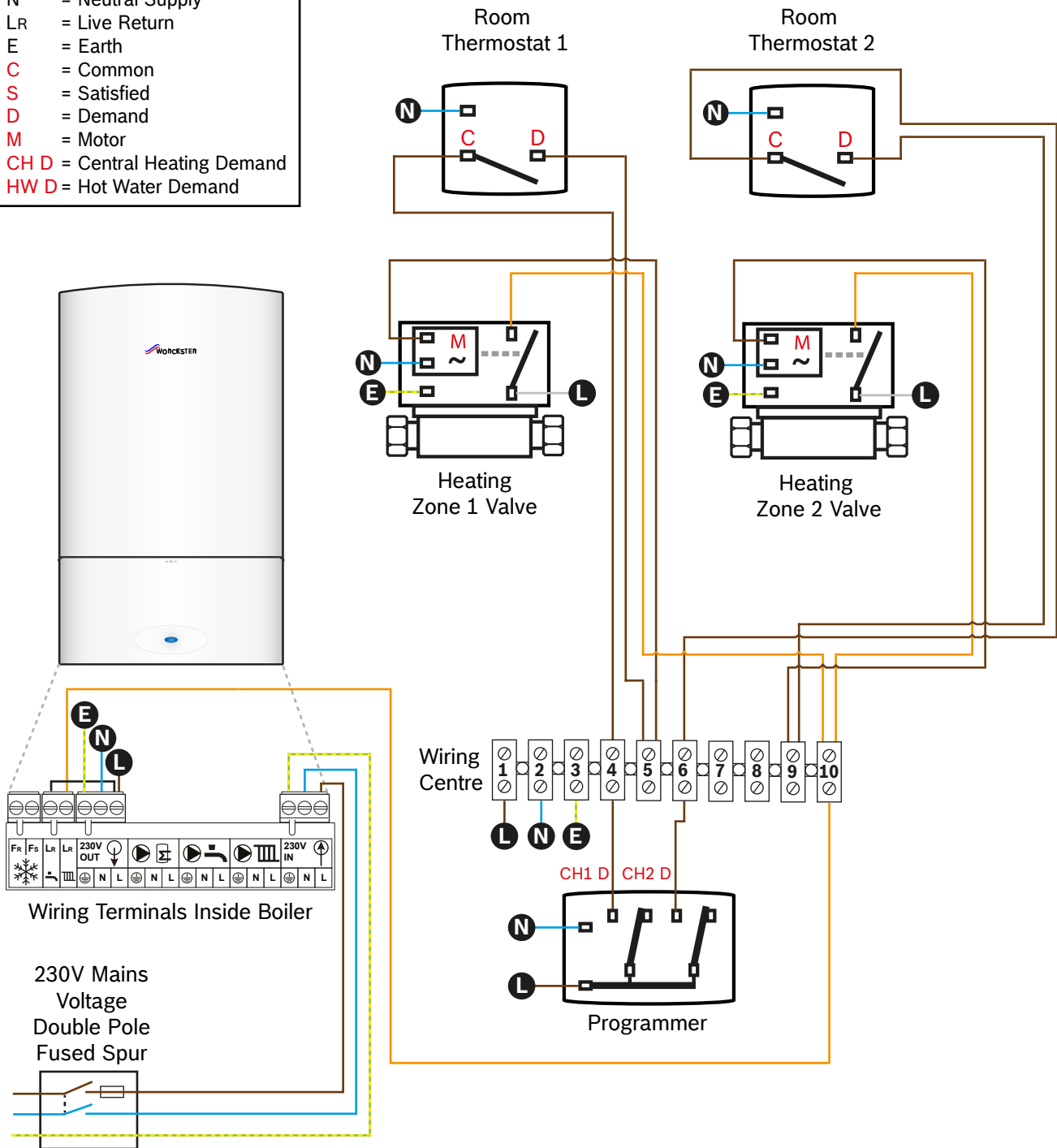

All electrical work should be carried out by a registered engineer. Wiring must comply with the latest IET wiring regulations. Isolate the mains electricity supply before starting any work and observe all relevant safety precautions. Refer to all relevant product installation manuals for safety and installation instructions. Whilst it is always our intention to fully assist, it is essential to recognise that all information given by the company is provided in good faith and based upon the information available. Connection labels may not match those of the products installed on site. We recommend that advice should always be checked with your installer, electrician or the manufacturer of the product in question. Consequently, the company cannot be held responsible for any liability relating to the use or repetition of such information or part thereof. In addition, whilst making every reasonable effort to monitor the performance and quality of our supply, installation and service network, we do not accept responsibility for the workmanship or operation of any third party company.

 The following labels and those like them are used to denote generic connections (such as the live supply to components) in order to simplify the diagram:  
**L** LIVE   **N** NEUTRAL   **E** EARTH

**Legend:**  
**L** = Live Supply  
**N** = Neutral Supply  
**LR** = Live Return  
**E** = Earth  
**C** = Common  
**S** = Satisfied  
**D** = Demand  
**M** = Motor  
**CH D** = Central Heating Demand  
**HW D** = Hot Water Demand

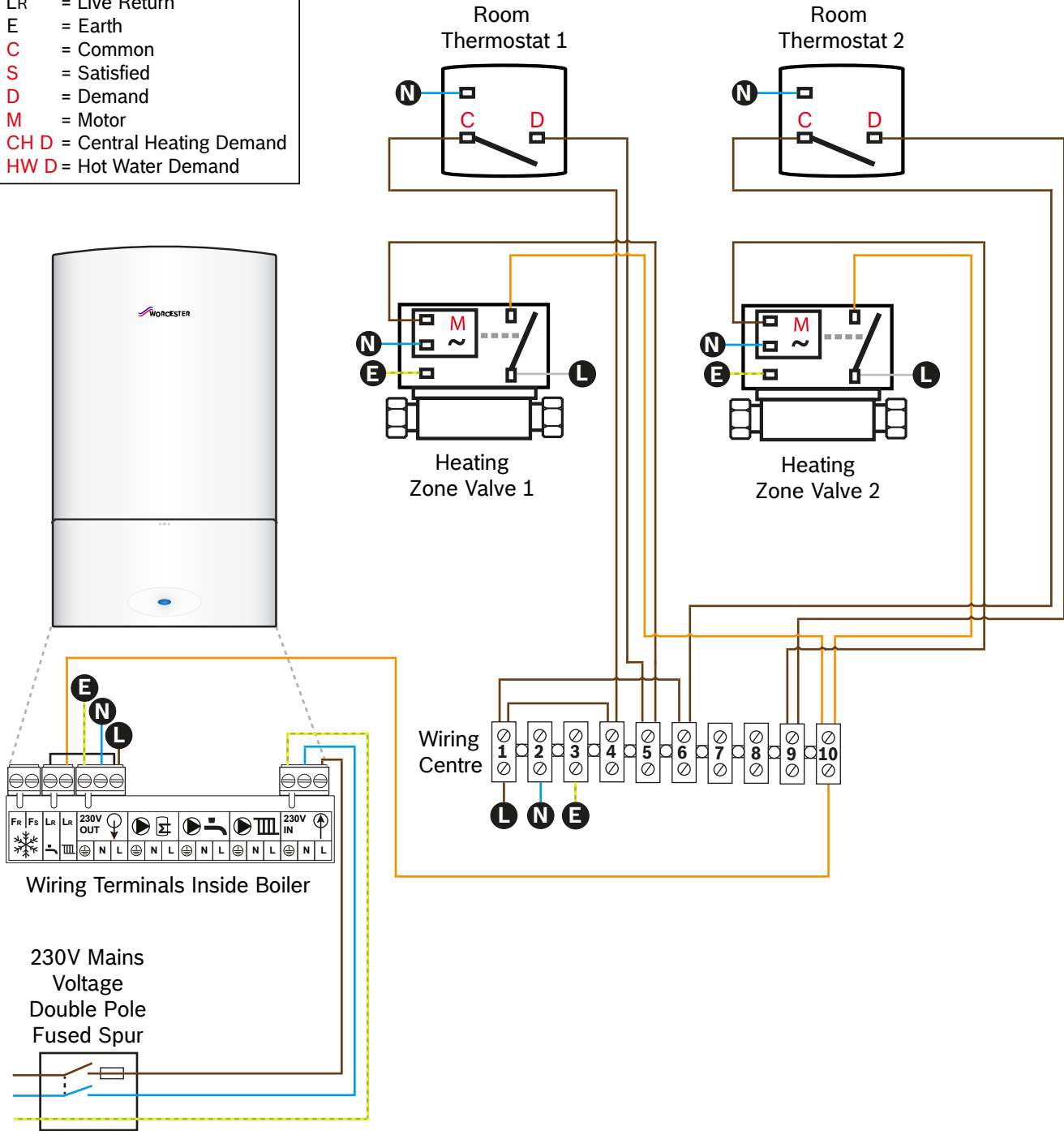

All electrical work should be carried out by a registered engineer. Wiring must comply with the latest IET wiring regulations. Isolate the mains electricity supply before starting any work and observe all relevant safety precautions. Refer to all relevant product installation manuals for safety and installation instructions. Whilst it is always our intention to fully assist, it is essential to recognise that all information given by the company is provided in good faith and based upon the information available. Connection labels may not match those of the products installed on site. We recommend that advice should always be checked with your installer, electrician or the manufacturer of the product in question. Consequently, the company cannot be held responsible for any liability relating to the use or repetition of such information or part thereof. In addition, whilst making every reasonable effort to monitor the performance and quality of our supply, installation and service network, we do not accept responsibility for the workmanship or operation of any third party company.

 The following labels and those like them are used to denote generic connections (such as the live supply to components) in order to simplify the diagram:

**L** LIVE   **N** NEUTRAL   **E** EARTH

**Legend:**

- L = Live Supply
- N = Neutral Supply
- LR = Live Return
- E = Earth
- C = Common
- S = Satisfied
- D = Demand
- M = Motor
- CH D = Central Heating Demand
- HW D = Hot Water Demand

### Programmable Thermostat

The Link between the live (L) and common (C) may already be fitted as part of the programmable thermostat, if not then a link must be wired in.

Room Thermostat 1

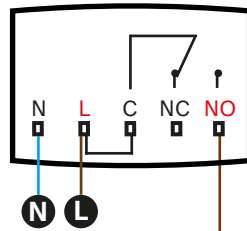

Room Thermostat 2

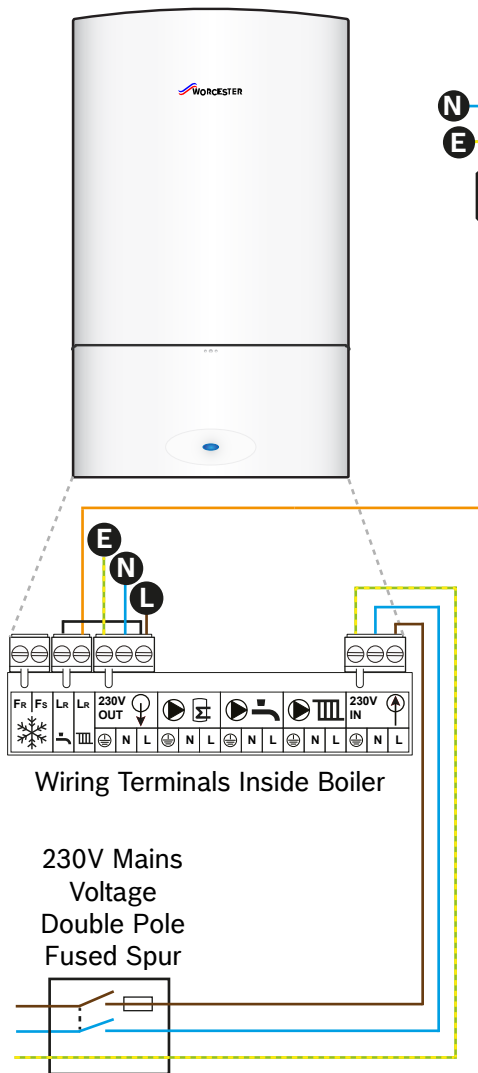
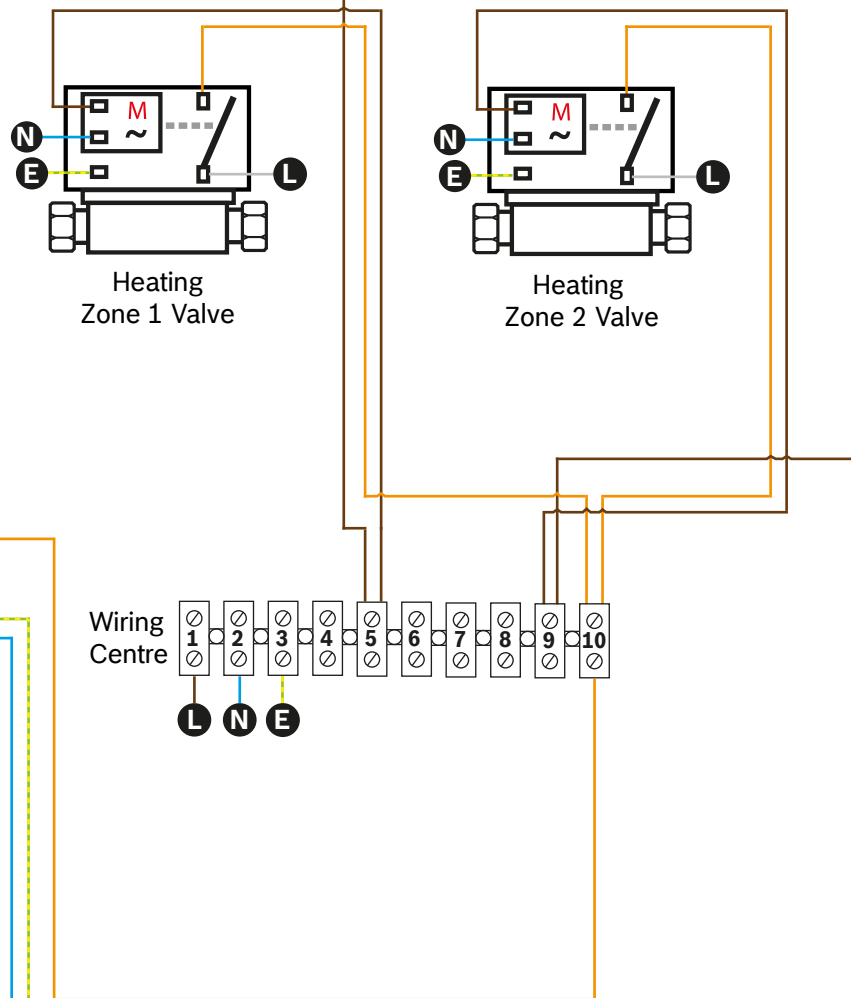
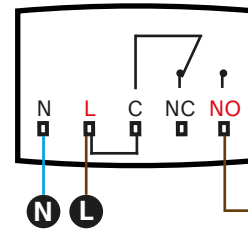

All electrical work should be carried out by a registered engineer. Wiring must comply with the latest IET wiring regulations. Isolate the mains electricity supply before starting any work and observe all relevant safety precautions. Refer to all relevant product installation manuals for safety and installation instructions. Whilst it is always our intention to fully assist, it is essential to recognise that all information given by the company is provided in good faith and based upon the information available. Connection labels may not match those of the products installed on site. We recommend that advice should always be checked with your installer, electrician or the manufacturer of the product in question. Consequently, the company cannot be held responsible for any liability relating to the use or repetition of such information or part thereof. In addition, whilst making every reasonable effort to monitor the performance and quality of our supply, installation and service network, we do not accept responsibility for the workmanship or operation of any third party company.

## Frost Protection (to System Bypass)

 The following labels and those like them are used to denote generic connections (such as the live supply to components) in order to simplify the diagram:  
**L** LIVE   **N** NEUTRAL   **E** EARTH

**Legend:**  
**L** = Live Supply  
**N** = Neutral Supply  
**LR** = Live Return  
**FR** = Frost Return  
**Fs** = Frost Supply  
**E** = Earth  
**C** = Common  
**S** = Satisfied  
**D** = Demand  
**M** = Motor  
**CH D** = Central Heating Demand  
**HW D** = Hot Water Demand

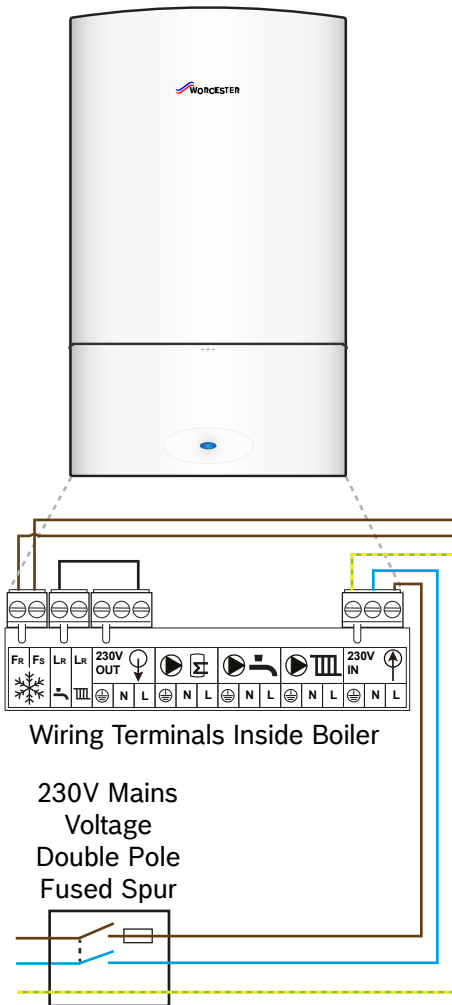
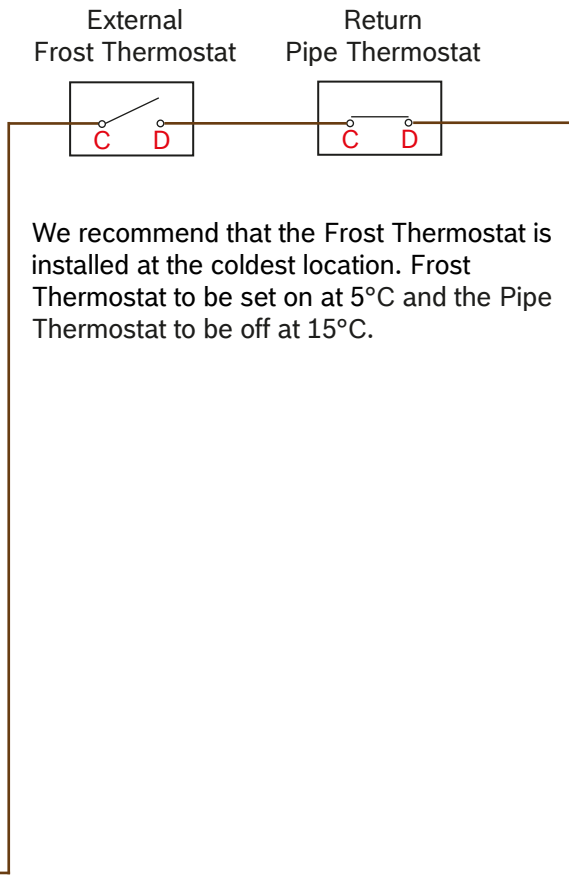

All electrical work should be carried out by a registered engineer. Wiring must comply with the latest IET wiring regulations. Isolate the mains electricity supply before starting any work and observe all relevant safety precautions. Refer to all relevant product installation manuals for safety and installation instructions. Whilst it is always our intention to fully assist, it is essential to recognise that all information given by the company is provided in good faith and based upon the information available. Connection labels may not match those of the products installed on site. We recommend that advice should always be checked with your installer, electrician or the manufacturer of the product in question. Consequently, the company cannot be held responsible for any liability relating to the use or repetition of such information or part thereof. In addition, whilst making every reasonable effort to monitor the performance and quality of our supply, installation and service network, we do not accept responsibility for the workmanship or operation of any third party company.



The following labels and those like them are used to denote generic connections (such as the live supply to components) in order to simplify the diagram:

**L** LIVE **N** NEUTRAL **E** EARTH

**Legend:**

- L = Live Supply
- N = Neutral Supply
- LR = Live Return
- FR = Frost Return
- FS = Frost Supply
- E = Earth
- C = Common
- S = Satisfied
- D = Demand
- M = Motor
- CH D = Central Heating Demand
- HW D = Hot Water Demand

**IMPORTANT NOTE:**

The Relay should be mounted within a suitable electrically safe housing.

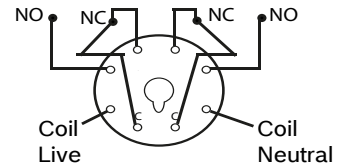

Example relay shown is a double Pole Mains Voltage Relay. This disables the boilers electrically in case of a fault condition.

Wiring From Zone/s Controls

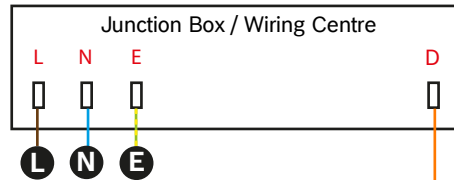

Header Limit Thermostat

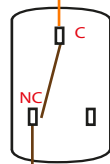

230V AC Double Pole Relay

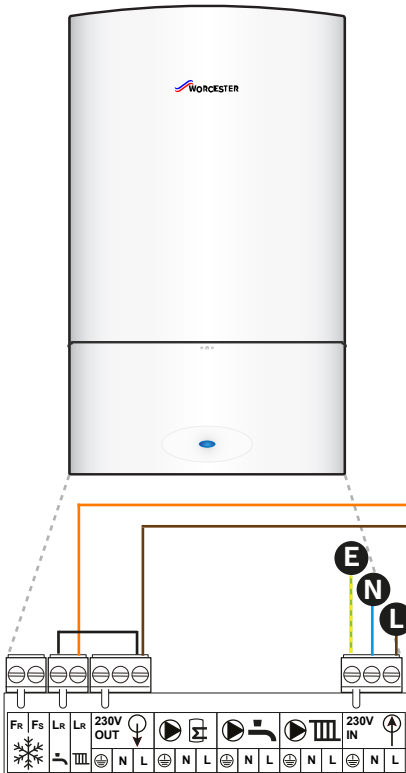
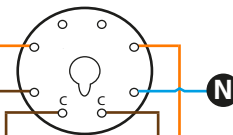

Wiring Terminals Inside Boiler

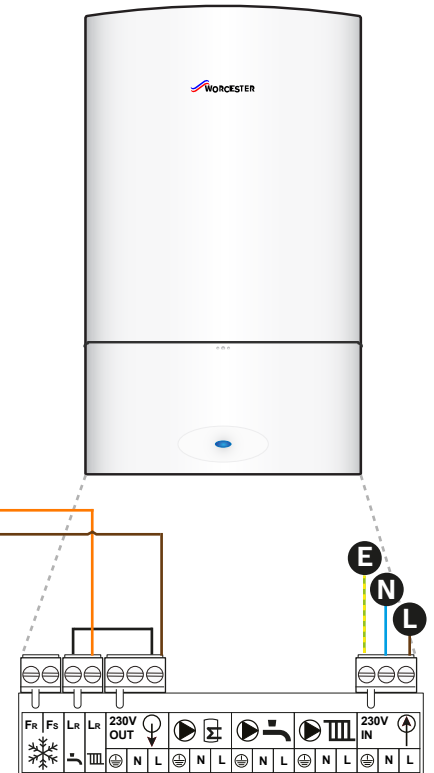

Wiring Terminals Inside Boiler

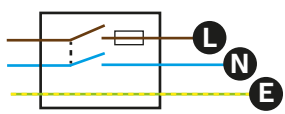

230V Mains Voltage Double Pole Fused Spur

All electrical work should be carried out by a registered engineer. Wiring must comply with the latest IET wiring regulations. Isolate the mains electricity supply before starting any work and observe all relevant safety precautions. Refer to all relevant product installation manuals for safety and installation instructions. Whilst it is always our intention to fully assist, it is essential to recognise that all information given by the company is provided in good faith and based upon the information available. Connection labels may not match those of the products installed on site. We recommend that advice should always be checked with your installer, electrician or the manufacturer of the product in question. Consequently, the company cannot be held responsible for any liability relating to the use or repetition of such information or part thereof. In addition, whilst making every reasonable effort to monitor the performance and quality of our supply, installation and service network, we do not accept responsibility for the workmanship or operation of any third party company.

 The following labels and those like them are used to denote generic connections (such as the live supply to components) in order to simplify the diagram:  
**L** LIVE   **N** NEUTRAL   **E** EARTH

**Legend:**  
**L** = Live Supply  
**N** = Neutral Supply  
**LR** = Live Return  
**E** = Earth  
**C** = Common  
**S** = Satisfied  
**D** = Demand  
**M** = Motor  
**CH D** = Central Heating Demand  
**HW D** = Hot Water Demand

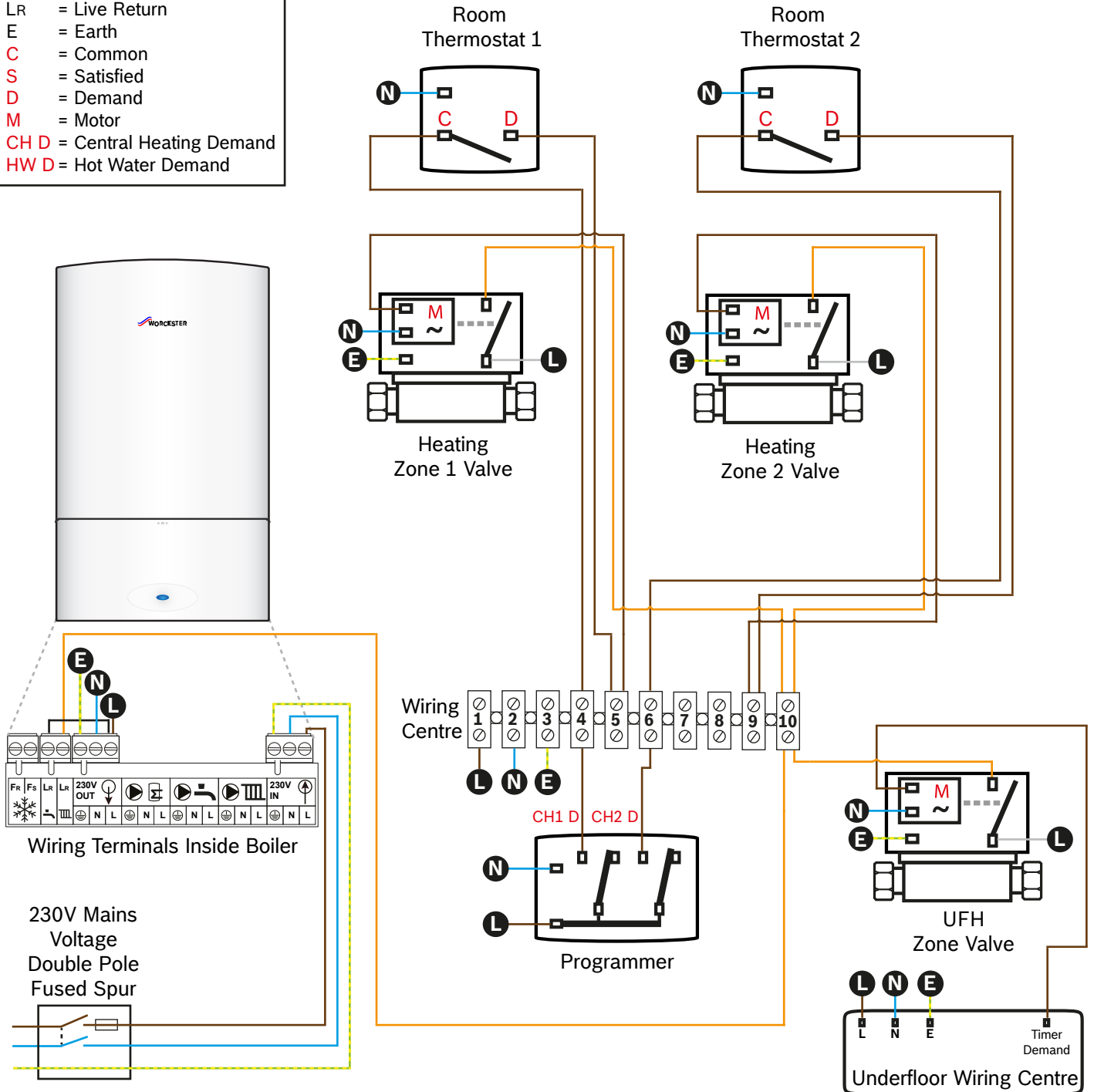

All electrical work should be carried out by a registered engineer. Wiring must comply with the latest IET wiring regulations. Isolate the mains electricity supply before starting any work and observe all relevant safety precautions. Refer to all relevant product installation manuals for safety and installation instructions. Whilst it is always our intention to fully assist, it is essential to recognise that all information given by the company is provided in good faith and based upon the information available. Connection labels may not match those of the products installed on site. We recommend that advice should always be checked with your installer, electrician or the manufacturer of the product in question. Consequently, the company cannot be held responsible for any liability relating to the use or repetition of such information or part thereof. In addition, whilst making every reasonable effort to monitor the performance and quality of our supply, installation and service network, we do not accept responsibility for the workmanship or operation of any third party company.