

## 2 Heating Zones

## 2H-R-E

 The following labels and those like them are used to denote generic connections (such as the live supply to components) in order to simplify the diagram:

**L** LIVE   **N** NEUTRAL   **E** EARTH

**Legend:**

L = Live  
N = Neutral  
LR = Live Return  
E = Earth  
C = Common  
S = Satisfied  
D = Demand  
M = Motor  
CH D = Central Heating Demand  
HW D = Hot Water Demand

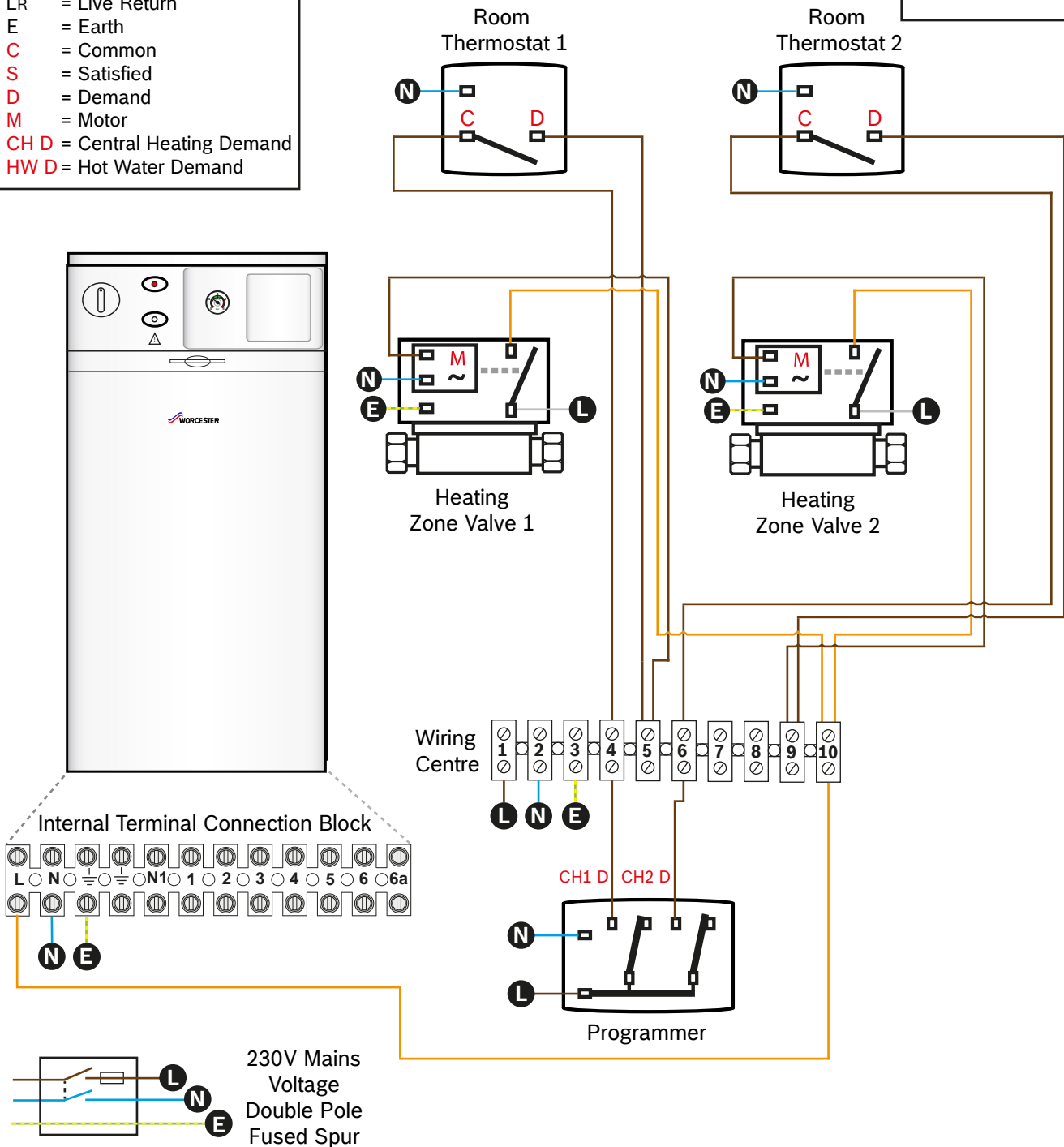
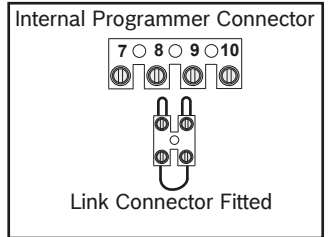

All electrical work should be carried out by a registered engineer. Wiring must comply with the latest IET wiring regulations. Isolate the mains electricity supply before starting any work and observe all relevant safety precautions. Refer to all relevant product installation manuals for safety and installation instructions. Whilst it is always our intention to fully assist, it is essential to recognise that all information given by the company is provided in good faith and based upon the information available. Connection labels may not match those of the products installed on site. We recommend that advice should always be checked with your installer, electrician or the manufacturer of the product in question. Consequently, the company cannot be held responsible for any liability relating to the use or repetition of such information or part thereof. In addition, whilst making every reasonable effort to monitor the performance and quality of our supply, installation and service network, we do not accept responsibility for the workmanship or operation of any third party company.

 The following labels and those like them are used to denote generic connections (such as the live supply to components) in order to simplify the diagram:  
**L** LIVE   **N** NEUTRAL   **E** EARTH

**Legend:**  
**L** = Live  
**N** = Neutral  
**E** = Earth  
**C** = Common  
**S** = Satisfied  
**D** = Demand  
**M** = Motor  
**CH D** = Central Heating Demand  
**HW D** = Hot Water Demand

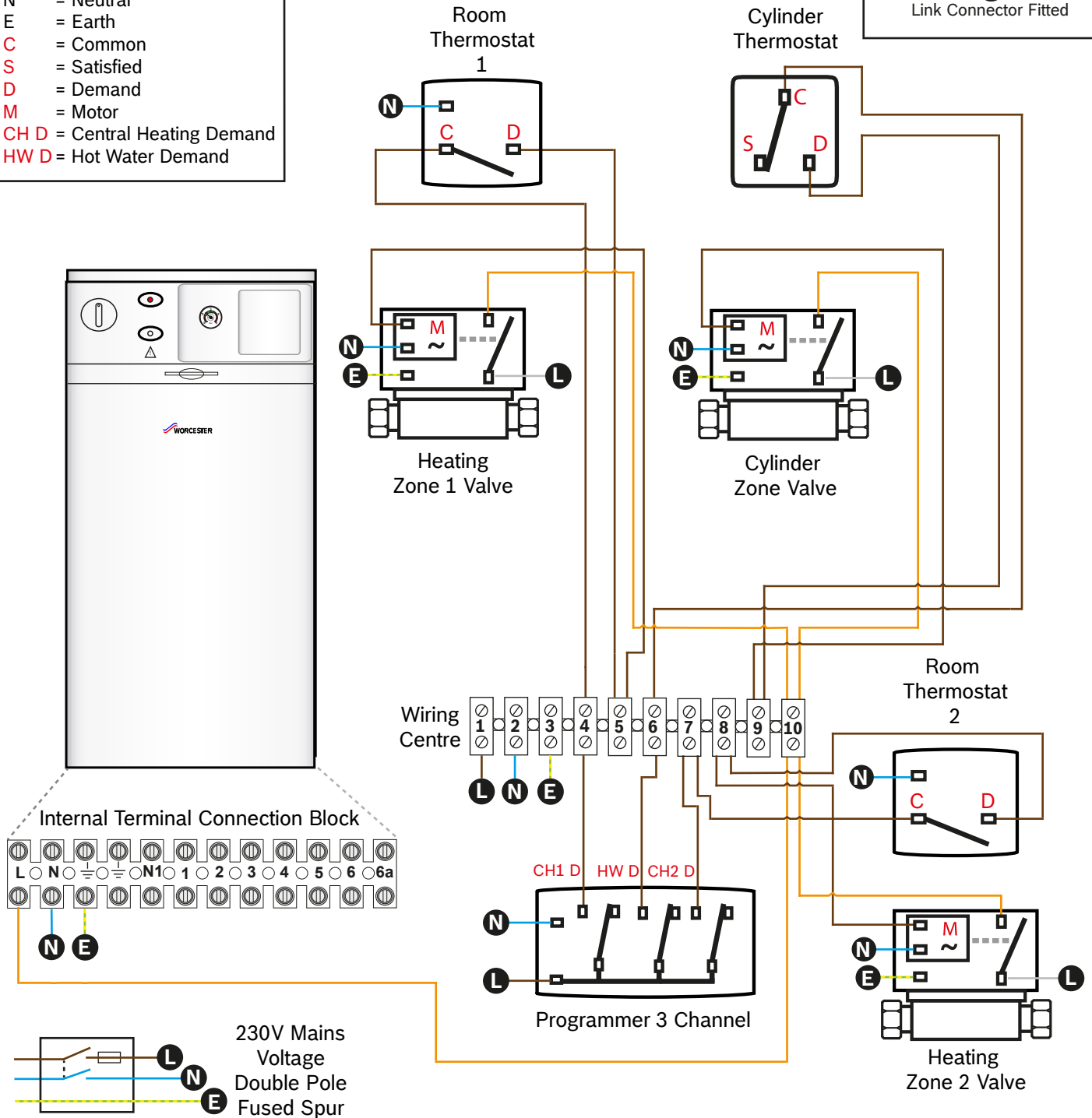
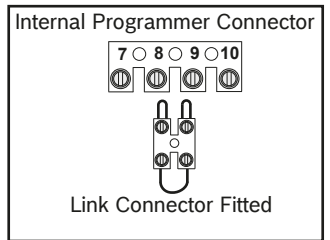

All electrical work should be carried out by a registered engineer. Wiring must comply with the latest IET wiring regulations. Isolate the mains electricity supply before starting any work and observe all relevant safety precautions. Refer to all relevant product installation manuals for safety and installation instructions. Whilst it is always our intention to fully assist, it is essential to recognise that all information given by the company is provided in good faith and based upon the information available. Connection labels may not match those of the products installed on site. We recommend that advice should always be checked with your installer, electrician or the manufacturer of the product in question. Consequently, the company cannot be held responsible for any liability relating to the use or repetition of such information or part thereof. In addition, whilst making every reasonable effort to monitor the performance and quality of our supply, installation and service network, we do not accept responsibility for the workmanship or operation of any third party company.

 The following labels and those like them are used to denote generic connections (such as the live supply to components) in order to simplify the diagram:

**L** LIVE   **N** NEUTRAL   **E** EARTH

**Legend:**

L = Live  
N = Neutral  
E = Earth  
C = Common  
S = Satisfied  
D = Demand  
M = Motor  
CH D = Central Heating Demand  
HW D = Hot Water Demand

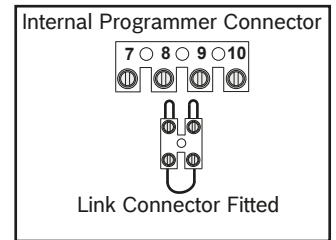

**Legend:**

L = Live  
N = Neutral  
E = Earth  
C = Common  
S = Satisfied  
D = Demand  
M = Motor  
CH D = Central Heating Demand  
HW D = Hot Water Demand

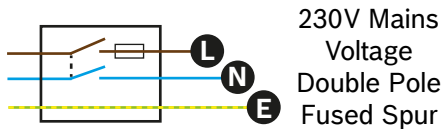
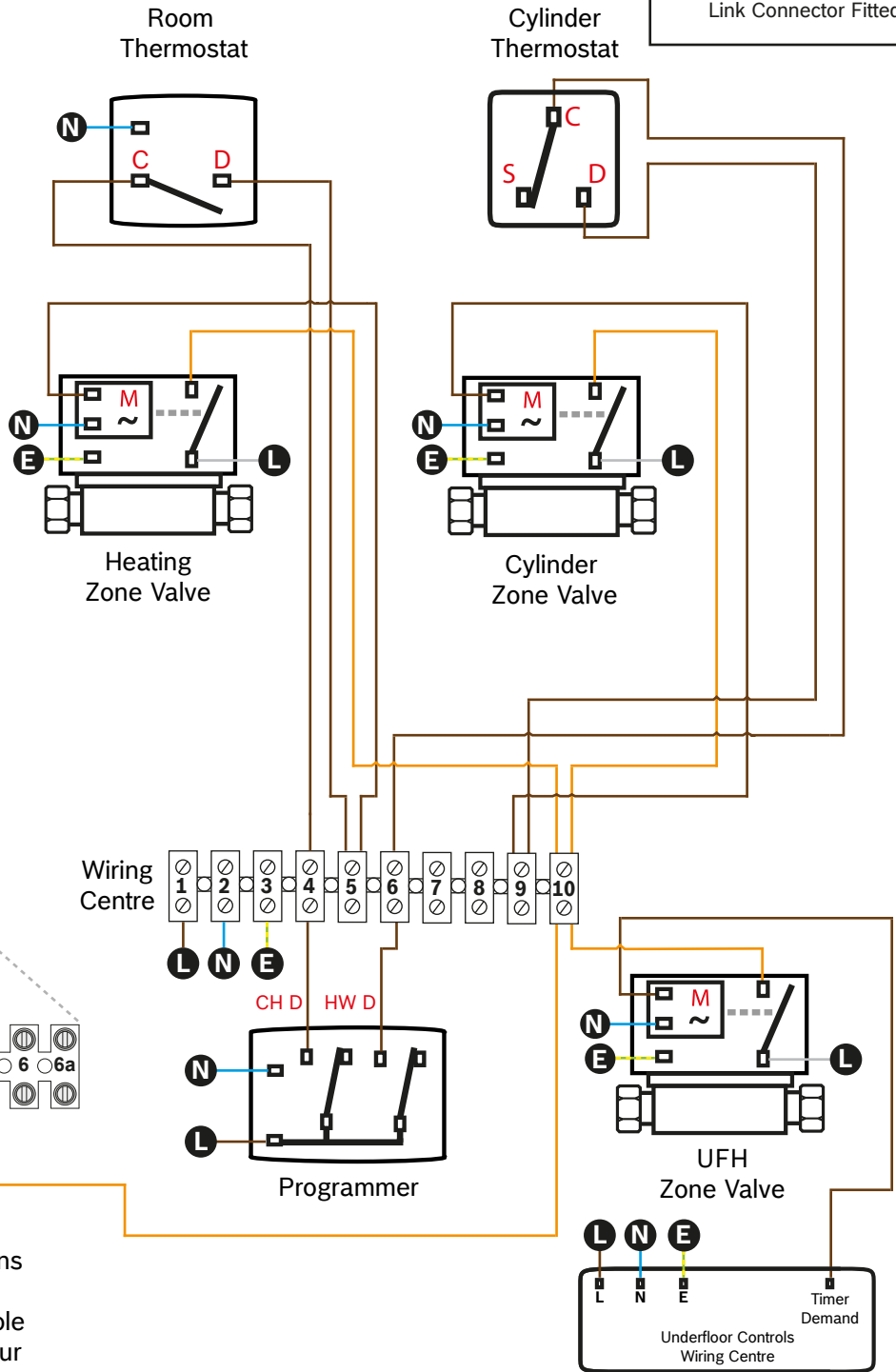
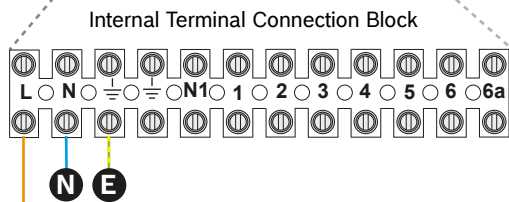

All electrical work should be carried out by a registered engineer. Wiring must comply with the latest IET wiring regulations. Isolate the mains electricity supply before starting any work and observe all relevant safety precautions. Refer to all relevant product installation manuals for safety and installation instructions. Whilst it is always our intention to fully assist, it is essential to recognise that all information given by the company is provided in good faith and based upon the information available. Connection labels may not match those of the products installed on site. We recommend that advice should always be checked with your installer, electrician or the manufacturer of the product in question. Consequently, the company cannot be held responsible for any liability relating to the use or repetition of such information or part thereof. In addition, whilst making every reasonable effort to monitor the performance and quality of our supply, installation and service network, we do not accept responsibility for the workmanship or operation of any third party company.

 The following labels and those like them are used to denote generic connections (such as the live supply to components) in order to simplify the diagram:

**L** LIVE   **N** NEUTRAL   **E** EARTH

**Legend:**

L = Live  
N = Neutral  
E = Earth  
C = Common  
S = Satisfied  
D = Demand  
M = Motor  
CH D = Central Heating Demand  
HW D = Hot Water Demand

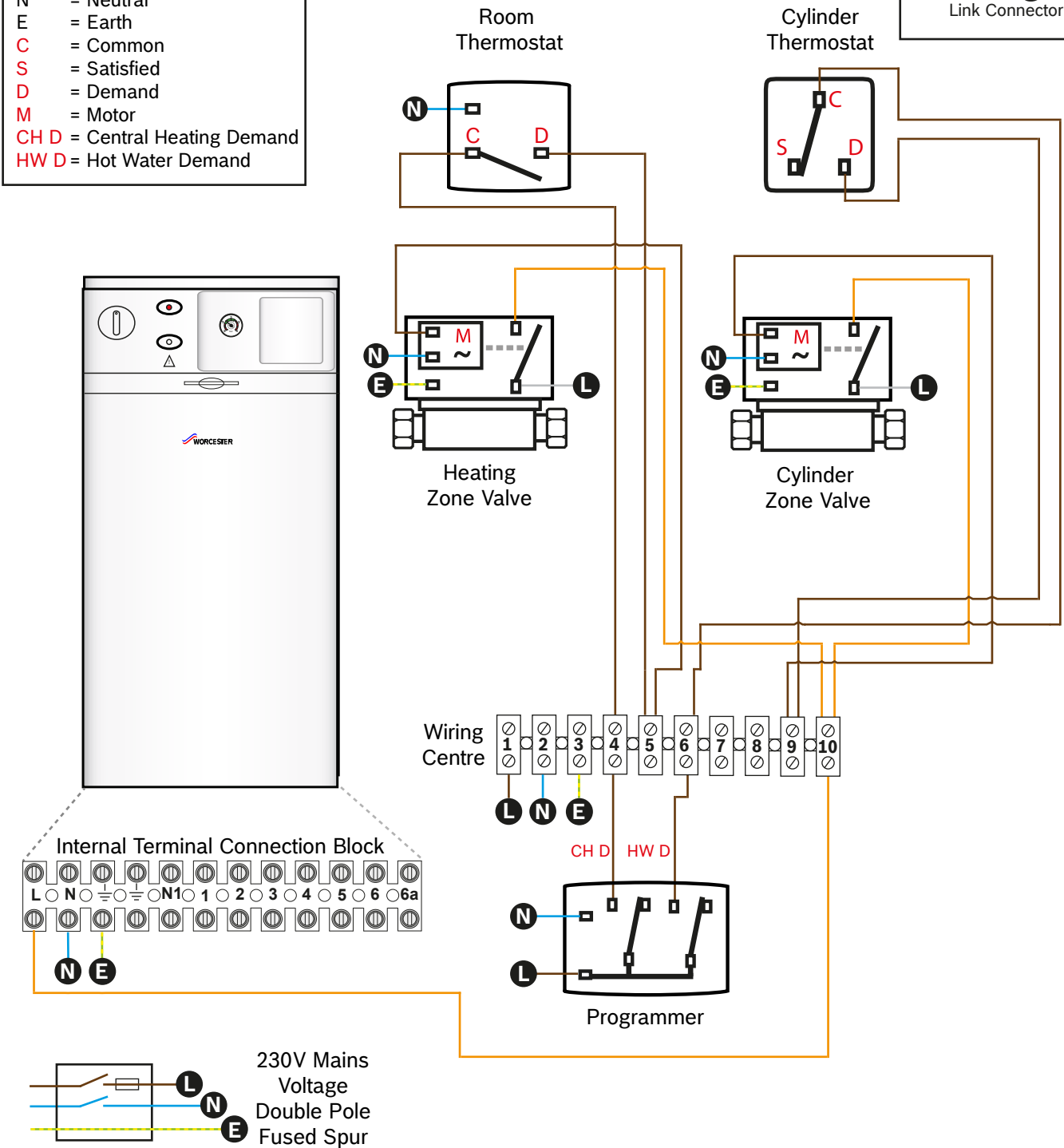
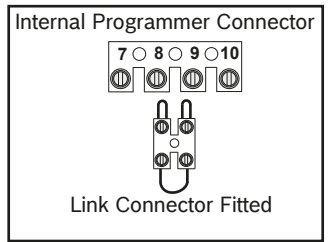

All electrical work should be carried out by a registered engineer. Wiring must comply with the latest IET wiring regulations. Isolate the mains electricity supply before starting any work and observe all relevant safety precautions. Refer to all relevant product installation manuals for safety and installation instructions. Whilst it is always our intention to fully assist, it is essential to recognise that all information given by the company is provided in good faith and based upon the information available. Connection labels may not match those of the products installed on site. We recommend that advice should always be checked with your installer, electrician or the manufacturer of the product in question. Consequently, the company cannot be held responsible for any liability relating to the use or repetition of such information or part thereof. In addition, whilst making every reasonable effort to monitor the performance and quality of our supply, installation and service network, we do not accept responsibility for the workmanship or operation of any third party company.

 The following labels and those like them are used to denote generic connections (such as the live supply to components) in order to simplify the diagram:  
**L** LIVE **N** NEUTRAL **E** EARTH

**Legend:**

- L = Live
- N = Neutral
- LR = Live Return
- E = Earth
- C = Common
- S = Satisfied
- D = Demand
- M = Motor
- CH D = Central Heating Demand
- HW D = Hot Water Demand

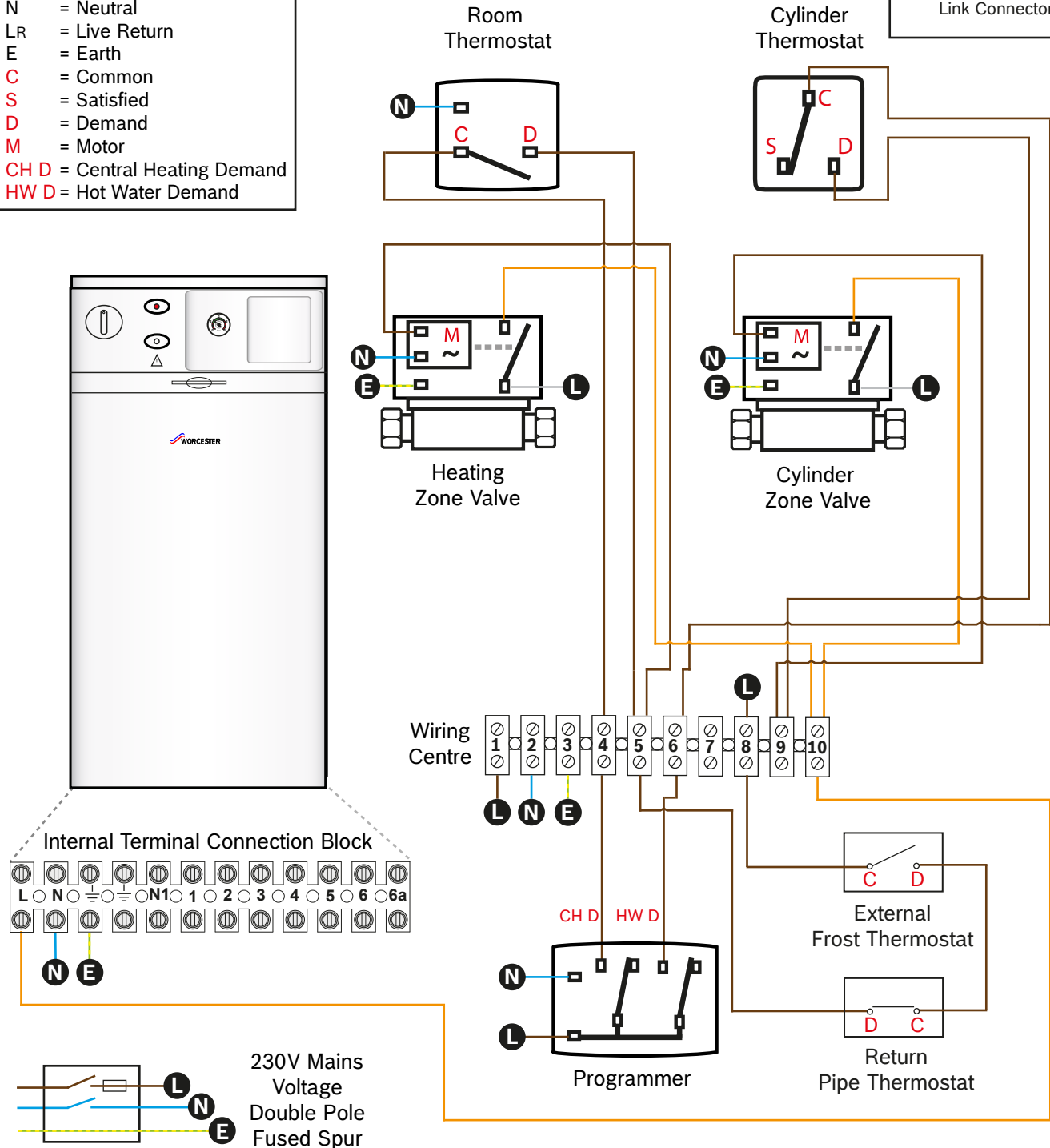
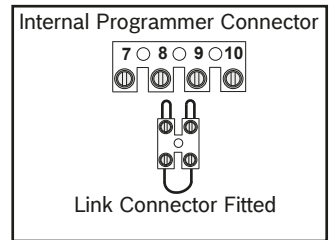

All electrical work should be carried out by a registered engineer. Wiring must comply with the latest IET wiring regulations. Isolate the mains electricity supply before starting any work and observe all relevant safety precautions. Refer to all relevant product installation manuals for safety and installation instructions. Whilst it is always our intention to fully assist, it is essential to recognise that all information given by the company is provided in good faith and based upon the information available. Connection labels may not match those of the products installed on site. We recommend that advice should always be checked with your installer, electrician or the manufacturer of the product in question. Consequently, the company cannot be held responsible for any liability relating to the use or repetition of such information or part thereof. In addition, whilst making every reasonable effort to monitor the performance and quality of our supply, installation and service network, we do not accept responsibility for the workmanship or operation of any third party company.

 The following labels and those like them are used to denote generic connections (such as the live supply to components) in order to simplify the diagram:

**L** LIVE   **N** NEUTRAL   **E** EARTH

**Legend:**

L = Live  
N = Neutral  
E = Earth  
C = Common  
S = Satisfied  
D = Demand  
M = Motor  
CH D = Central Heating Demand  
HW D = Hot Water Demand  
HW O = Hot Water Off

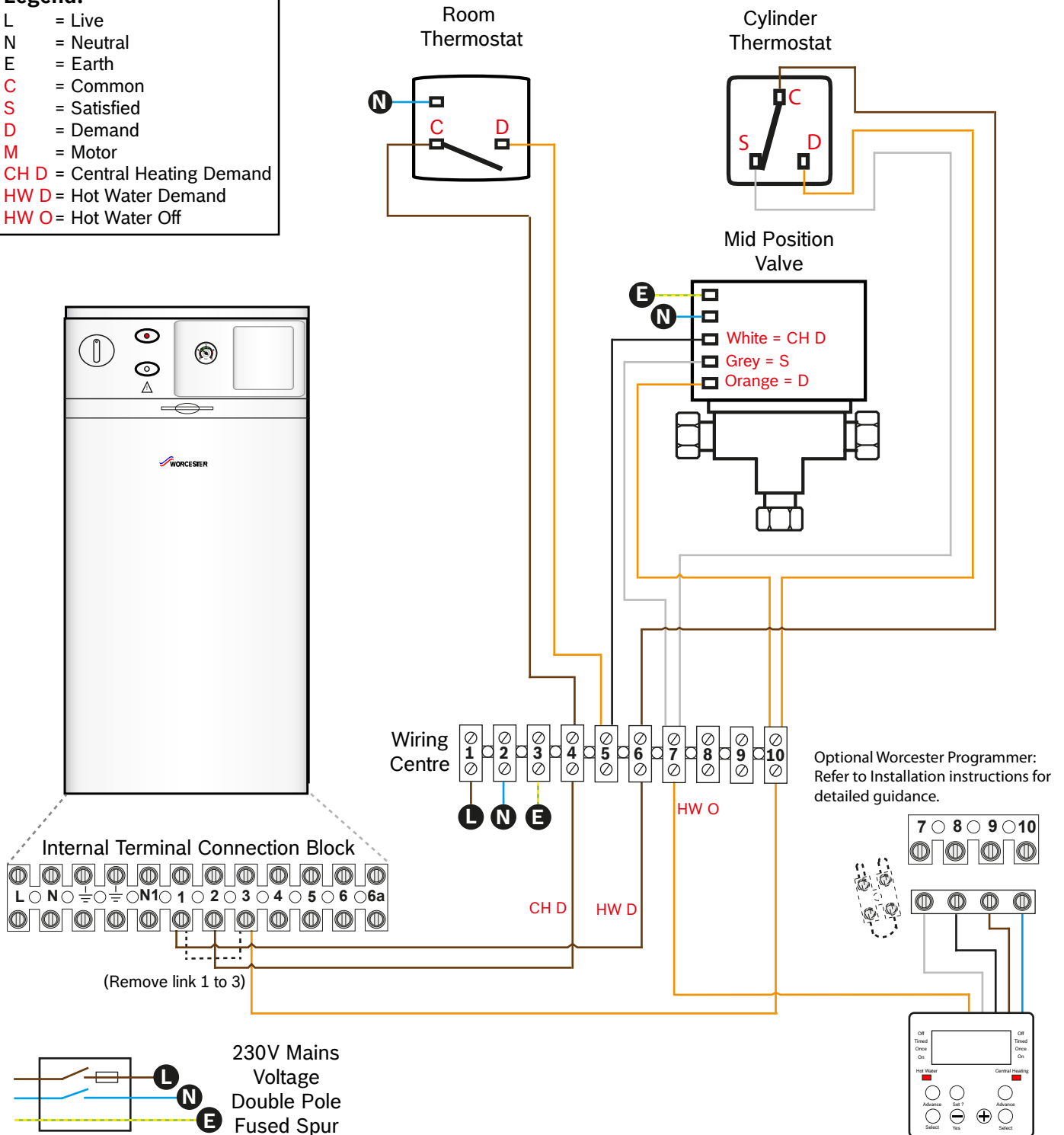

All electrical work should be carried out by a registered engineer. Wiring must comply with the latest IET wiring regulations. Isolate the mains electricity supply before starting any work and observe all relevant safety precautions. Refer to all relevant product installation manuals for safety and installation instructions. Whilst it is always our intention to fully assist, it is essential to recognise that all information given by the company is provided in good faith and based upon the information available. Connection labels may not match those of the products installed on site. We recommend that advice should always be checked with your installer, electrician or the manufacturer of the product in question. Consequently, the company cannot be held responsible for any liability relating to the use or repetition of such information or part thereof. In addition, whilst making every reasonable effort to monitor the performance and quality of our supply, installation and service network, we do not accept responsibility for the workmanship or operation of any third party company.