



BOSCH

Compress 7001i Installer guide

Flexible, future-proofed heating



Installer
guide

Compress 7001i AW

Flexible, future-proofed heating

Low maintenance, low carbon, and low energy – the CS7001i is designed to be a favourite among installers and homeowners alike.

With everything you'd expect from Bosch, the CS7001i is a high efficiency, semi monobloc heat pump with a raft of smart features which make it suitable for small to medium homes, in renovation or new build projects.

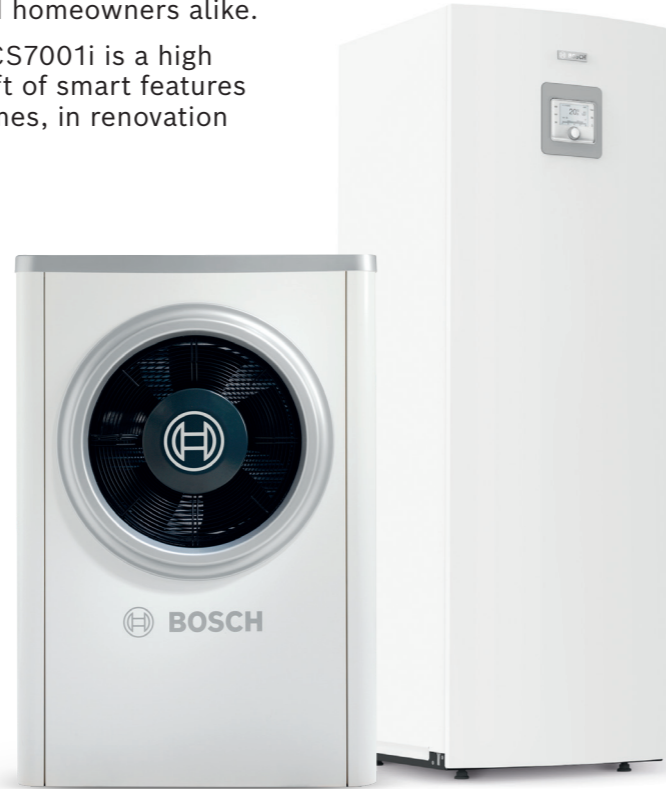

Why install the Compress 7001i AW?



Quiet quality
Enjoy the peace with low noise



Powerful
Range of outputs for larger homes



Bosch quality
Top quality design guaranteed



Efficient
A+++ rated heating[^]



Simple
Easy-to-use temperature controls



Responsible
Lower carbon home heating

Air to water

Quiet, powerful and simple to use



Neighbour and neighbourhood friendly, the CS7001i is super quiet from just 47dB(A). With a sleek design and low running volume, this unobtrusive heat pump will be a fast favourite for forward-thinking homes.

And with power outputs from 5kW – 17kW, you've got a solution up your sleeve, whatever the shape and size of the property.

Why choose Bosch?



Tried and tested

With over 15 years of expertise, Bosch is an established leader in heat pumps.



Get ahead

Training and support to go from newbie to expert.



End-to-end support

We've got your back – with marketing, technical, and design teams always on-hand.

Simple to install

Easy to control



Ultra-quiet

The CS7001i's low noise maximises peace and tranquility around the home and garden.

High performance

Delivering seasonal coefficient of performance SCOP of 4.77 (MCS figures) at 35° on the 7kW model and is A+++ rated so can be relied upon to deliver home comfort in even the coldest of temperatures.



Simple indoor unit

All essential system components in one place, including expansion vessel, pump and valves.

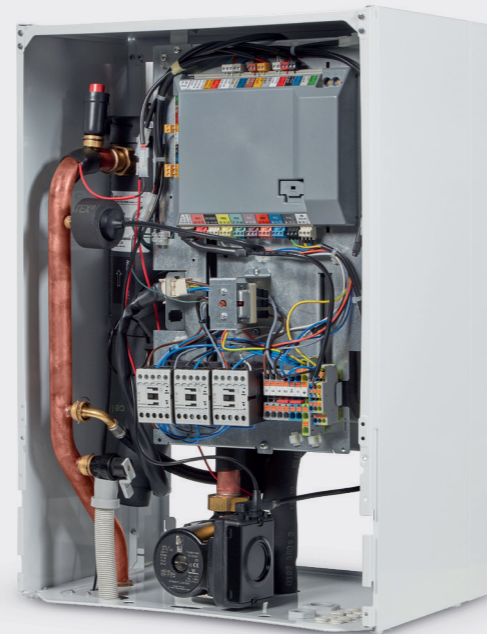

Connected and easy

Integrated HMI within the indoor unit, so customers can simply control their heat pump. For extra comfort, the CR10H room controller is also available.

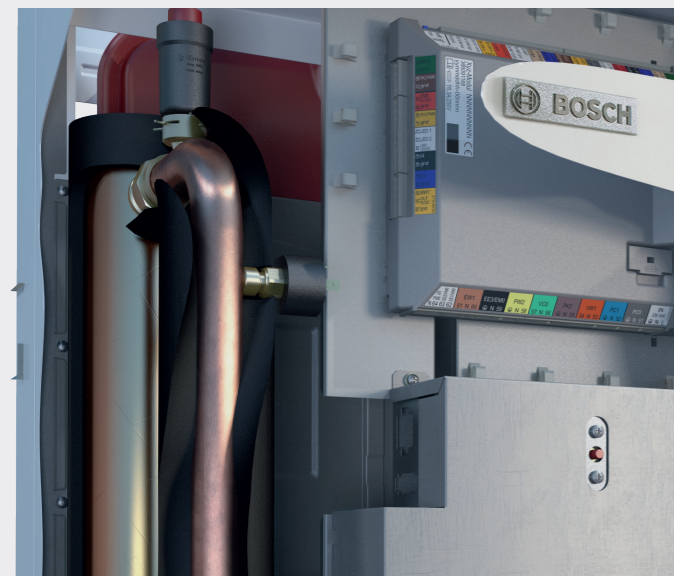

Pre-configured indoor unit

For quick and easy installation with a built in multi-functional back up electric booster for heating and hot water.

Hello hybrid heating

Bring boilers and heat pumps together with the hybrid unit that can be coupled with our 4-9kW outdoor units.



Outdoor unit

The inside story

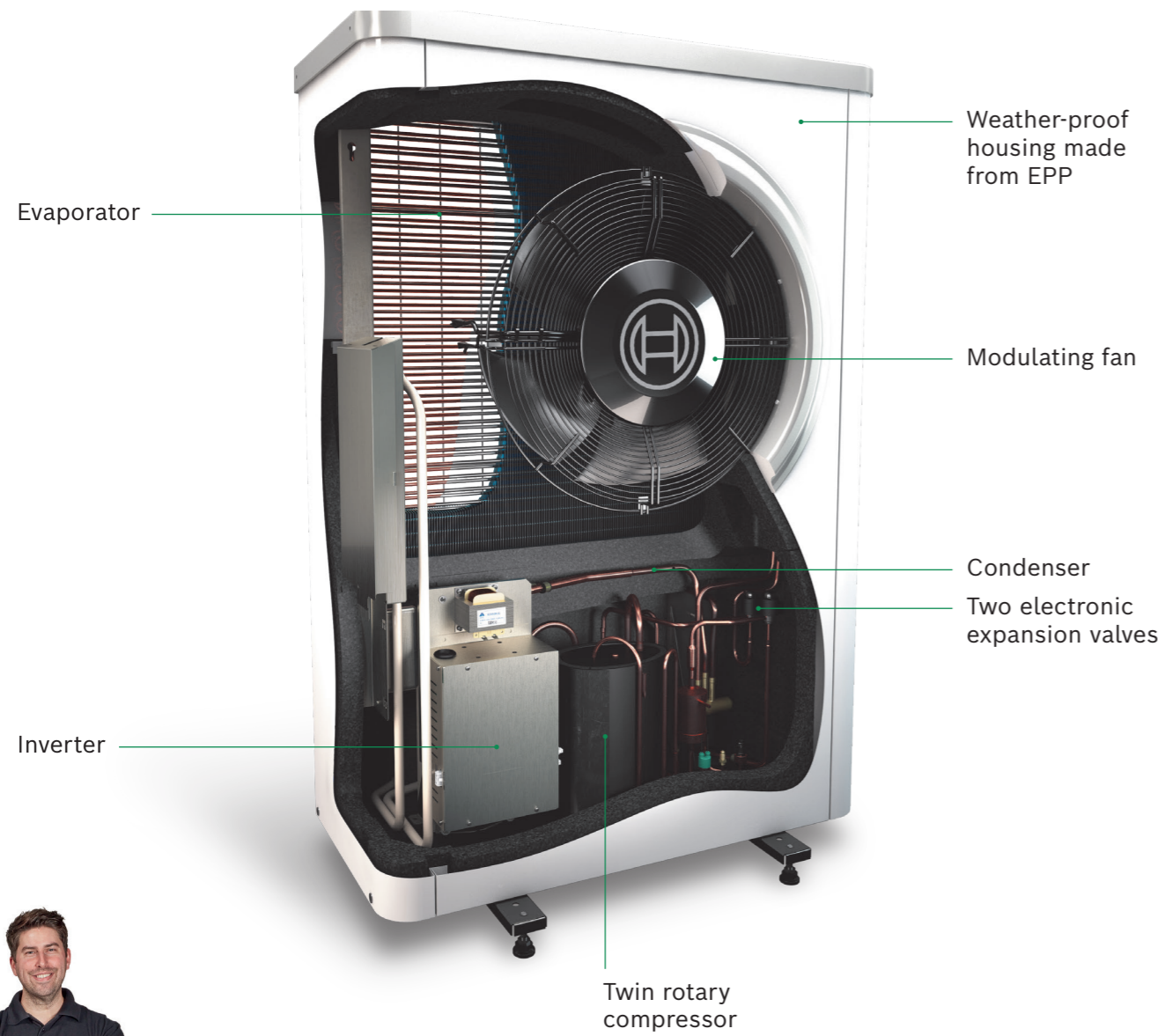

The high performing Compress 7001i makes installation simple for experienced or new installers.

Darren Danks,
Bosch Product Manager

Indoor heat pump units

The inside story

This all-in-one **freestanding tower unit** includes a 190 litre hot water storage cylinder with key system components.

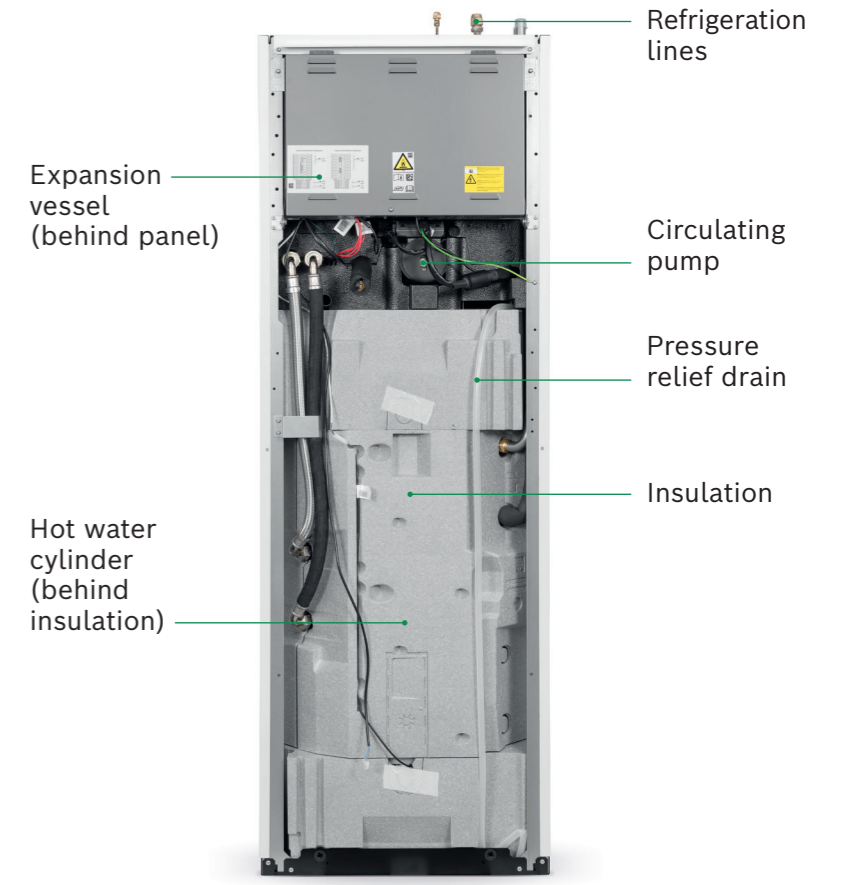
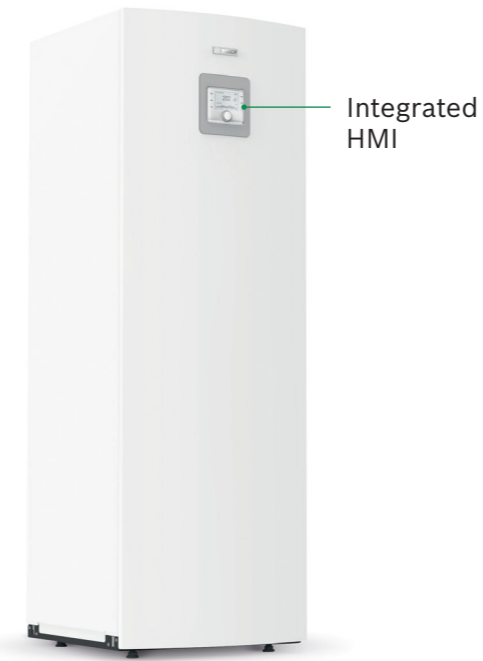

This **wall-mounted unit** offers a flexible range of options in combination with various hot water storage solutions.

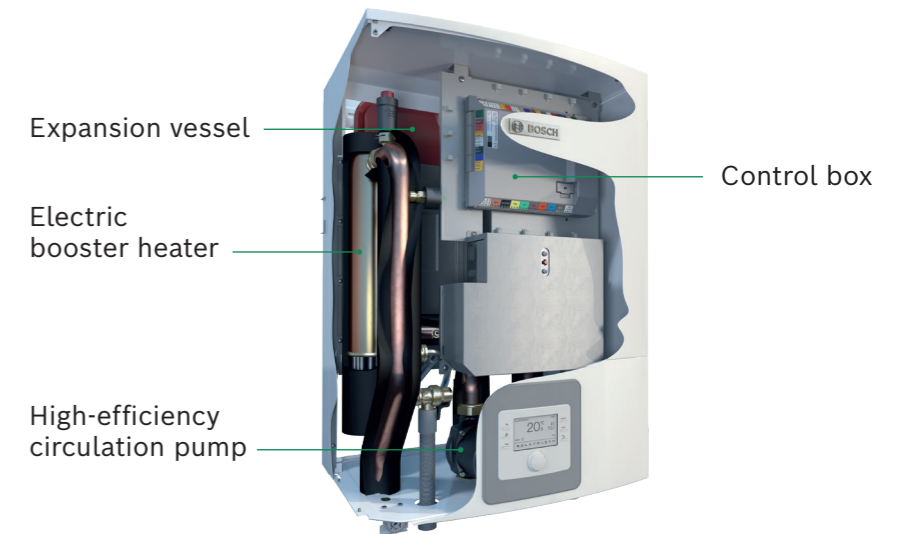

Indoor unit (Hybrid) The inside story

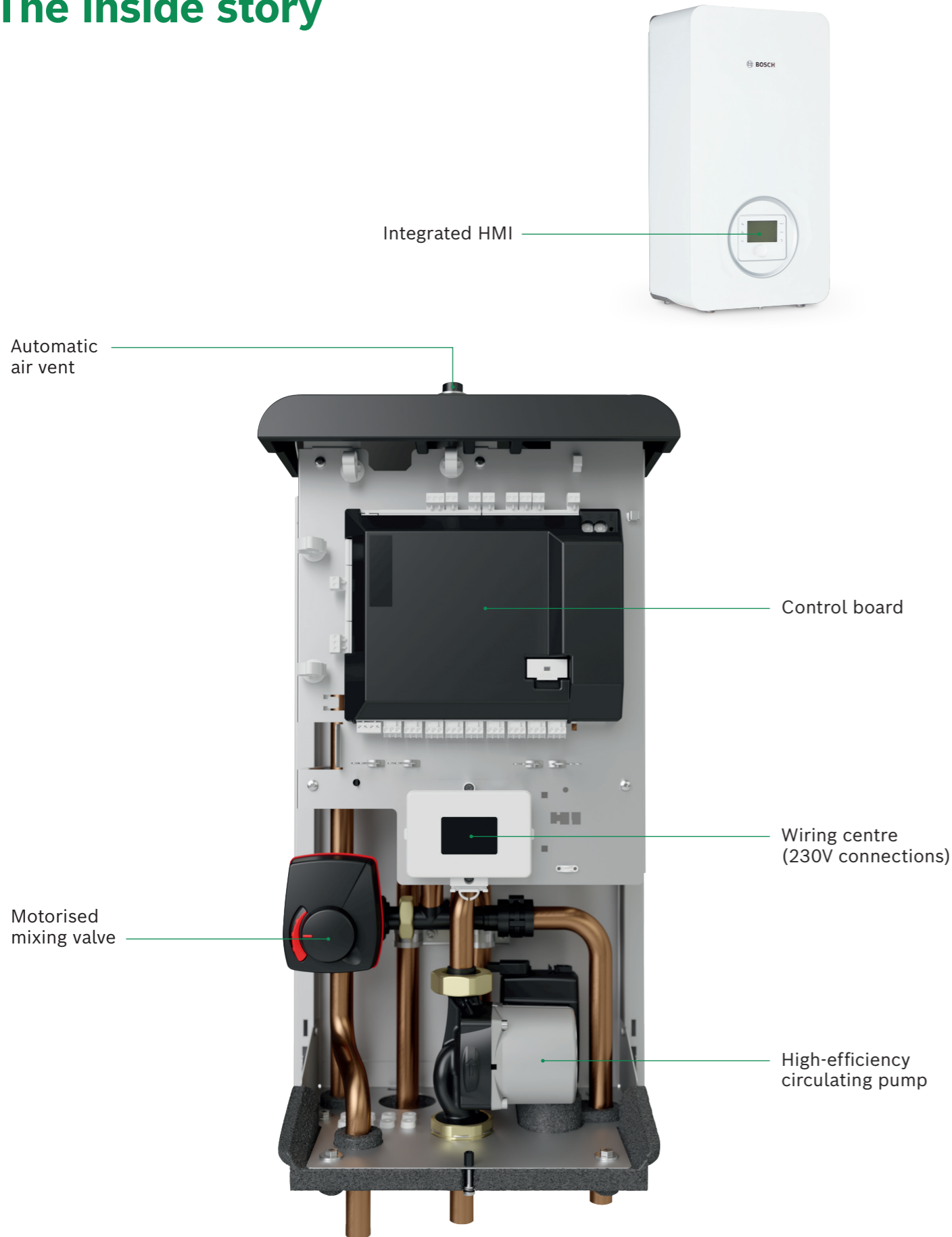

System options

Flexible and future ready, the CS7001i is available in 4 setups: a standalone heat pump, a hybrid with combi, or hybrid with system boiler.

Heat pump system



Heat pump system

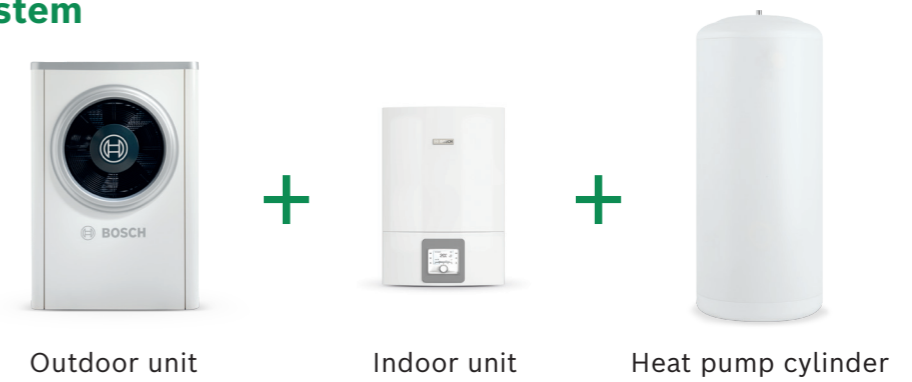

Hybrid system – with combi boiler*



Hybrid system – with system boiler**



*Compatible with natural gas, LPG and oil boilers.
**Compatible with natural gas and LPG boilers with integral diverter valve.

Clearances

The illustrations below show some possible system configurations and the necessary minimum clearances.

Rear air inlets
These must be a minimum of 400mm from any obstruction.

Front air outlets
There must be a minimum 2000mm clear zone in front of each unit.

Please refer to manual for detailed clearances

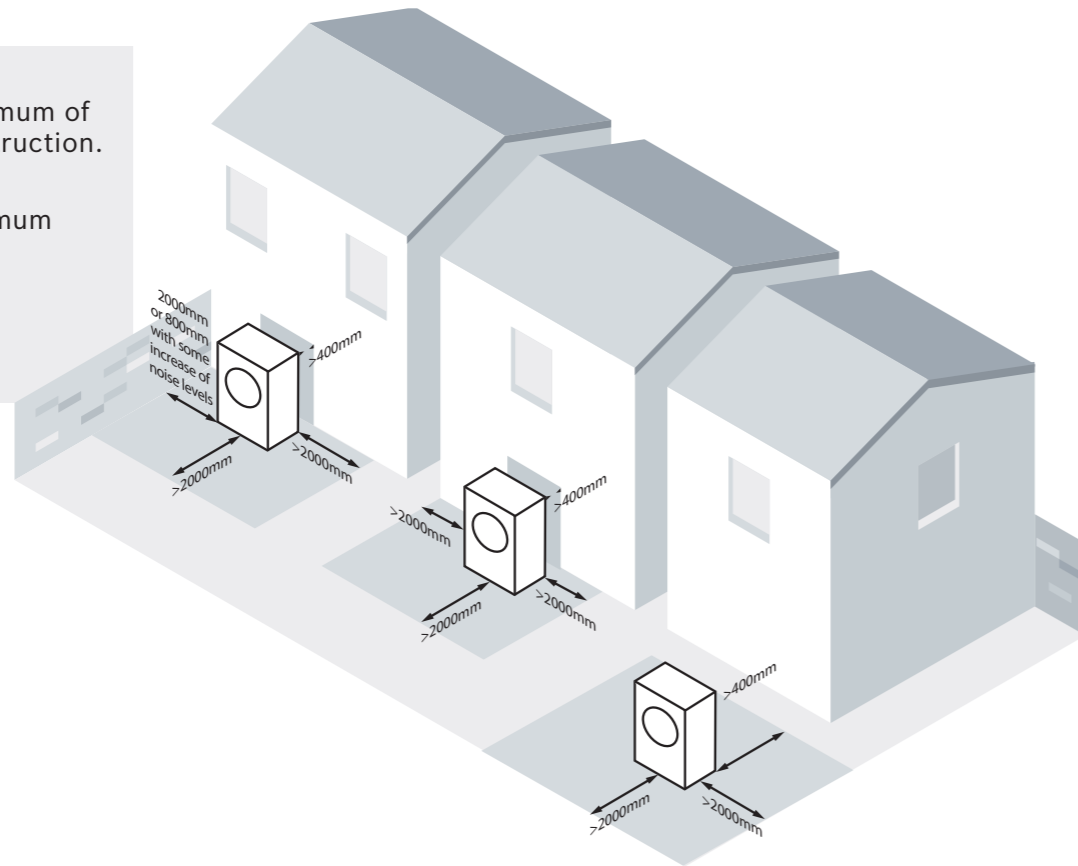

Dimensions



Key information

Outdoor unit

Model	5kW	7kW	9kW	13kW	17kW
Part number	8 738 210 255	8 738 210 256	8 738 210 257	7 738 602 089	7 738 601 998
Dimensions	Width	930mm	930mm	930mm	1122mm
	Height	1380mm	1380mm	1380mm	1695mm
	Depth	440mm	440mm	440mm	545mm
Cubic dimensions	0.565m ³	0.565m ³	0.565m ³	1.036m ³	1.036m ³
Weight	106kg	107kg	114kg	182kg	193kg

Tower unit

Model	5-9kW	13-17kW
Part number	8 738 212 649	8 738 212 650
Dimensions	Width	600mm
	Height	1800mm
	Depth	650mm
Weight	145kg	150kg

Indoor unit

Model	5-9kW	13-17kW
Part number	8 733 602 107	8 733 602 108
Dimensions	Width	485mm
	Height	700mm
	Depth	386mm
Weight	32kg	32kg

Hybrid indoor unit

Model	Hybrid AWS	
Part number	8 732 948 754	
Dimensions	Width	350mm
	Height	706mm
	Depth	243mm
Weight	18kg	

Siting information

Tower unit – clearances

Front: 800mm Left/Right: 50mm Top: 400mm

Indoor unit – clearances

Front: 800mm Left/Right: 50mm Top: 550mm

Hybrid unit – clearances

Front: 800mm Left/Right: 50mm Top: 550mm

Heating performance

These graphs explain the output performance variations of each CS7001i output. They show the water temperature achievable in radiators in relation to the outdoor temperature. This information will help you to select the most appropriate model for your customer's home.

CS7001i 35°C

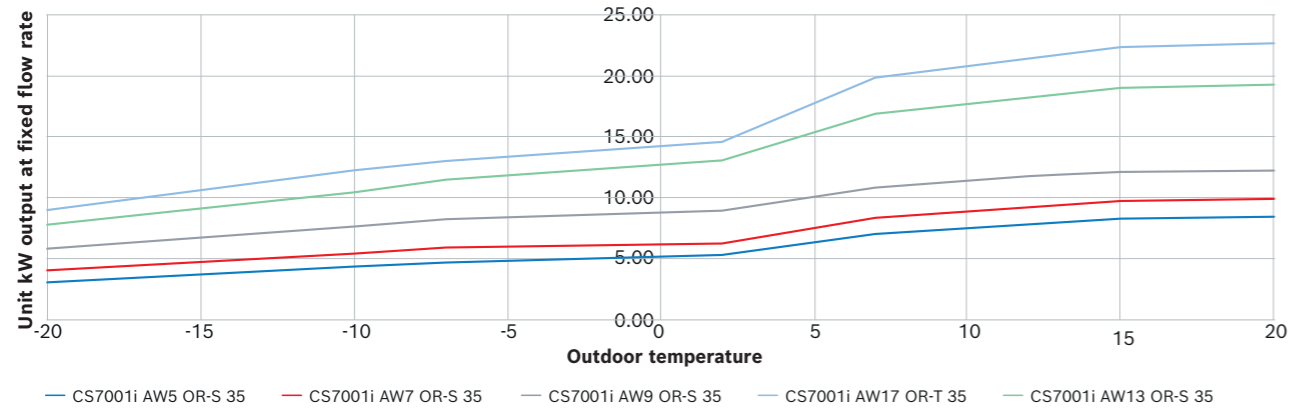

CS7001i 45°C

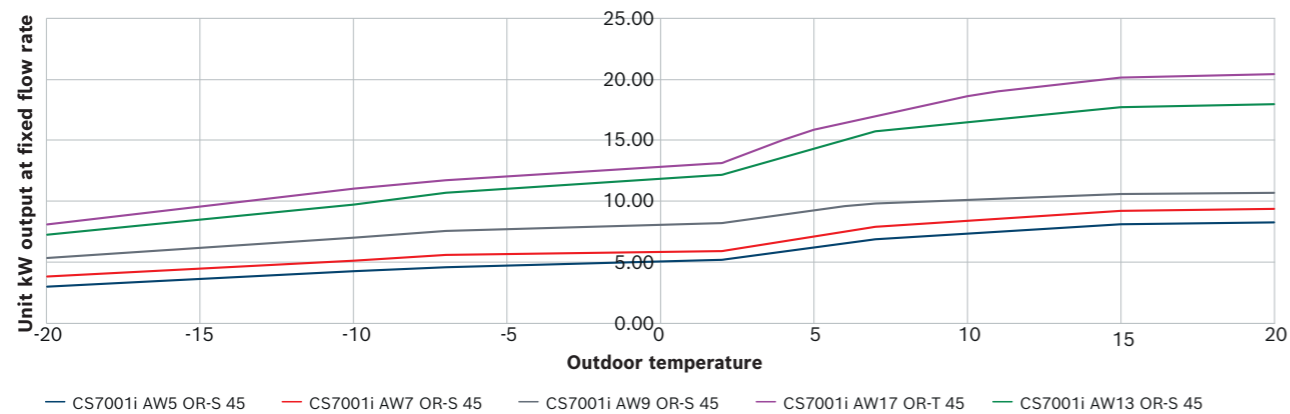

CS7001i 55°C

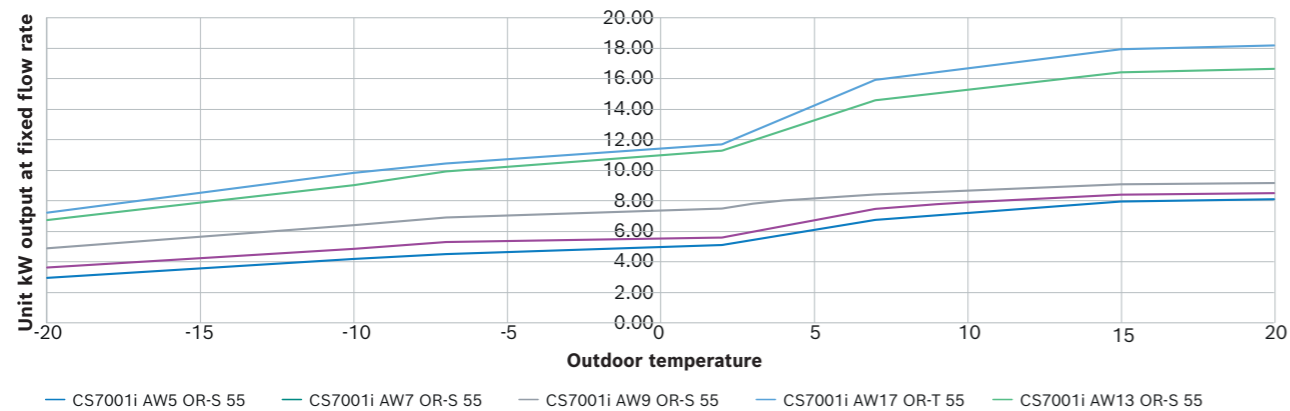

Schematics

CS7001i AW OR-S 1 X RAD, 1 X UFH DHW, buffer and 3rd party controls

Key	Description	Details
	3rd Party Controls	
	Isolation Valve	
	Filter	
CW	Inlet Control Group	
	Room Thermostat	Specified by 3rd Party
	Pump	
	2 Port Valve	
	Non Return Valve	
	Flow Temp. Sensor	Refer to instructions for location
	Outdoor Sensor	Refer to instructions for location
	Cylinder Sensor	

T1 Sensor to be fitted on North facing wall where possible. Please refer to installation manual for guidance.
Controls for heating system to be specified by third party.

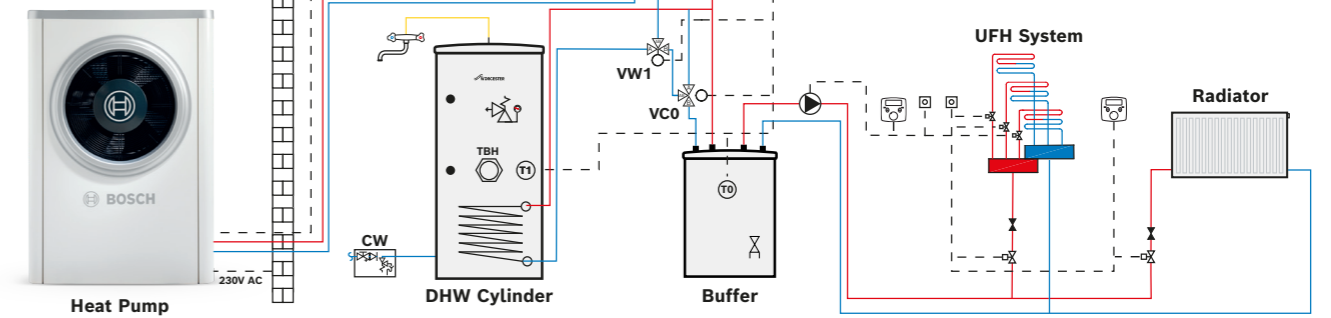

All electrical work should be carried out by a registered engineer. Wiring must comply with the latest NSAI wiring regulations. Isolate the mains electricity supply before starting any work and observe all relevant safety precautions. Refer to all relevant product installation manuals for safety and installation instructions. Whilst it is always our intention to fully assist, it is essential to recognise that all information given by the company is provided in good faith and based upon the information available. Connection labels may not match those of the products installed on site. We recommend that advice should always be checked with your installer, electrician or the manufacturer of the product in question. Consequently, the company cannot be held responsible for any liability relating to the use or repetition of such information or part thereof. In addition, whilst making every reasonable effort to monitor the performance and quality of our supply, installation and service network, we do not accept responsibility for the workmanship or operation of any third party company.

Technical data

CS7001i Technical data	CS7001i 5kW	CS7001i 7kW	CS7001i 9kW	CS7001i 13kW	CS7001i 17kW
Part number (outdoor unit)	8 738 210 255	8 738 210 256	8 738 210 257	7 738 602 089	7 738 601 998
Part number (indoor unit)	7 738 602 107	7 738 602 107	7 738 602 107	7 738 602 108	7 738 602 108
Energy efficiency class (35°C)	A+++				
Energy efficiency class (55°C)	A++				
Coefficient of performance (COP) at +7/W35	4.69	5.31	5.02	4.68	4.87
Seasonal coefficient of performance (SCOP) (35°C)	4.41	4.77	4.57	4.6	3.35
Seasonal coefficient of performance (SCOP) (55°C)	3.22	3.43	3.44	3.38	2.85
Sound Power (ErP) – in accordance with EN 12102 (Nominal A7/W55)	47dB(A)	47dB(A)	48dB(A)	55dB(A)	53dB(A)
Refrigerant type	R410A				
Compressor type	Twin rotary compressor				
Power supply - outdoor unit	230V 1N AC 50Hz				400V 3N AC 50Hz
Electric booster heater (standard)	Yes				
Working outdoor temperature range (heating)	-20/35°C				
Heating power at A-7/W35*	4.7	5.93	6.21	11.5	13.02

Hybrid indoor unit	Hybrid AWS 8 738 808 679
Compatible with (heat pump)	5kW (8 738 210 255), 7kW (8 738 210 256), 9kW (8 738 210 257)
Dimensions (HxWxD mm)	706 x 350 x 246
Weight (kg)	18
Connections	22mm copper(22mm copper to 3/4" MBSP fittings supplied)
Sound pressure level (dBA)	36
Maximum operating pressure	3 bar
Ingress protection	IPX1D
Heat pump switching	Bosch EMS
Boiler switching	230V
Boiler type	Up to 32kW for heating

Parts and accessories

Accessories	Part number
3-way valve (22mm)	8 738 201 412
3-way valve (28mm)	8 738 201 411
CANbus cable 2x2x0.752 15m	8 738 206 183
CANbus cable 2x2x0.752 30m	8 738 206 184
CR10H Controller	7 738 112 314
MM100 Mixer (multi-zone controller)	7 738 110 140
Heating cable CSC/TS 2m/30W/230V	7 719 003 296
Heating cable CSC/TS 3m/45W/230V	7 719 003 297
Heating cable CSC/TS 5m/75W/230V	7 719 003 298
Assembly INPA hose	8 733 716 993
Bosch CR10H (room thermostat)	7 738 112 314
Bracket Kit for MM100	8 738 205 073
Dew point sensor	7 747 204 698
Sound hood 5-9kW (front)	8 733 709 284
Sound hood 5-9kW (back)	8 733 709 037
Sound hood 13-17kW (front)	8 733 709 289
Sound hood 13-17kW (back)	8 733 709 042
Alarm buzzer	8 738 206 696
50L Buffer vessel	7 716 161 061
120L Buffer vessel	7 735 500 777
Green Storage WB Range Heat Pump Cylinder 150	7 733 601 189
Green Storage WB Range Heat Pump Cylinder 180	7 733 601 333
Green Storage WB Range Heat Pump Cylinder 210	7 733 601 334
Green Storage WB Range Heat Pump Cylinder 250	7 733 601 335
Green Storage WB Range Heat Pump Cylinder 300	7 733 601 336
Pump Group HS25/6 s BO	7 736 601 142
Pump Group HS25/6 BO	7 733 601 144
Pump Group HSM25/6 BO	7 733 601 148
Pump Group HS25/6 MM100 BO	7 733 601 151
Pump Group HSM25/6 MM100 BO	7 733 601 155
Optional accessories available directly from merchant	
Rubber feet	See merchant
UV and frost protection pipe insulation	See merchant

Training

Ready for a heating revolution?

Wherever you are in your low carbon heating journey, from starting out to adding to your heat pump expertise, we can support you.

Our product training courses will help you get hands-on experience and understand all the features and benefits, specification, installation, and servicing.





Heat pumps should only be installed, brought into operation and maintained by a competent professional.



Explore our product training

Share

We would love to see your installations!

-  Worcester Bosch Professional
-  @WorcesterBoschProfessional
-  @WorcesterBosch
-  Worcester Bosch
-  Worcester Bosch Group

Bosch Home Comfort

Cotswold Way
Warndon
Worcester
WR4 9SW

worcester-bosch.ie

Calls to and from Bosch Thermotechnology Ltd may be recorded for training and quality assurance purposes. Worcester Bosch is a brand name of Bosch Thermotechnology Ltd. This brochure is accurate at the date of printing, but may be superseded and should be disregarded if specification and/or appearances are changed in the interest of continued improvement. The statutory rights of the consumer are not affected.