

Installation and Operation Manual

Operating unit

Greenstar Sense I

Intelligent Wired Room Thermostat



6 720 648 748-00.10

UK/IE



WORCESTER
Bosch Group

Contents

1	Key to symbols and safety instructions	3
1.1	Explanation of symbols	3
1.2	Safety regulations	3
2	Product details	4
2.1	Product data for energy consumption	5
2.2	Technical specifications	6
2.3	Function as room temperature-dependent controller	6
2.4	Function as zone controller	6
2.5	Function as an intelligent room thermostat	7
3	Old electrical and electronic appliances	7
4	Operation	8
5	Information for installer	9
5.1	Mounting	9
5.2	Commissioning	12
5.3	Settings in the service menu	13
6	Troubleshooting	15
6.1	Temperature-related faults	15
6.2	Display of a current fault	16

1 Key to symbols and safety instructions

1.1 Explanation of symbols

Symbol	Meaning
▶	Action step
→	Cross-reference to other parts of this document or to other documents
•	List/list entry
-	List/list entry (second level)
	Flashing display (e.g. flashing 4)

1.2 Safety regulations

Installation and commissioning

- ▶ Observe all UK regulations and standards during installation and operation.
- ▶ Observe all instructions to ensure correct operation.
- ▶ Ensure the Sense I is installed and commissioned by a competent person.
- ▶ Do not install the Sense I in wet rooms.
- ▶ Install and commission the heat source and other accessories according to the relevant instructions.
- ▶ Do not connect the Sense I to the 230 V mains.
- ▶ Before installing the Sense I: electrically isolate the heat source and all other BUS units from the power supply and secure against unintentional reconnection.

Risk of damage due to operator error

Operator errors can result in injury and/or property damage.

- ▶ Instruct the customer of the functions and operation of the Sense I.
- ▶ Make sure that children do not operate the Sense I without supervision.
- ▶ Make sure that only individuals who can operate the Sense I correctly have access to it.

2.1 Product data for energy consumption

The specified product data correspond to the requirements of the EU Regulation No. 811/2013 which supplements ErP Directive 2010/30/EU. The class of the temperature controller is required to calculate the room heating energy efficiency of an integrated system and is for this reason incorporated into the system data sheet.



Features of the Sense I	Class ¹⁾	[%] ^{1),2)}	
Sense I			
Load Compensation: Modulating room thermostat for use with modulating heaters. Electronic room thermostat that varies the flow temperature and output of the heating appliance to achieve desired room temperature.	V	3,0	●
Sense I & a wiring module³⁾		 &  ≥ 3x	
Multi-sensor Room Temperature Control: As class V but within a heating system comprised of 3 or more Sense I Intelligent Wired Room Thermostats and, therefore, an aggregated room temperature	VIII	5,0	●

Table 1 Product data for energy efficiency of the Sense I

- 1) Class according to EU-Regulation No. 811/2013 for designation of packages of combination heater
 - 2) Contribution to seasonal space heating energy efficiency in %
 - 3) A Greenstar Wiring Centre is required to control the 3 Sense I Intelligent Room Thermostats
- Delivery state

2.2 Technical specifications

Technical data	CE
Measurements (W × H × D)	82 × 82 × 23 mm
Rated voltage	10 – 24 V DC
Rated current	4 mA
BUS interface	EMS/EMS 2 (2-wire BUS)
Control range	5 – 30 °C
Permiss. ambient temperature	0 – 60 °C
IP rating	III
Protection class	IP20

2.3 Function as room temperature-dependent controller

The Sense I monitors the room temperature and controls the flow temperature from the heat source to deliver the required room temperature. Must be used with a compatible time control.

Load Compensation: The heat output of the heat source changes according to the deviation between the current and required room temperature. This method of control is suitable for buildings with one temperature level, e. g. open-plan living area. There are fewer burner starts and shorter pump runtimes thus increasing efficiency and reducing fuel consumption. Depending on the connected heat source, this control mode might possibly be not available.

Flow temperature control: The flow temperature changes according to the deviation between the current and required room temperature. This method of control is suitable for major load fluctuations and is suitable for buildings with different temperature zones. The precision of control is higher and the flow temperature is limited. This saves fuel.

The pump run times can be reduced with the optimised pump run.

2.4 Function as zone controller

The Sense I can be used as a controller for a maximum of 4 heating circuits without a higher-level control, in combination with a wiring module (for further information refer to the technical documentation of the wiring module). For additional time

control of the zones a Sense II can be used instead of a Sense I (combination of 1 Sense II and a maximum of 2 Sense I with a wiring module).

The control of the zone temperature is thus achieved in the same way as in the case of the function as room temperature-dependent controller with adjusted flow temperature control. This is the default factory setting.

2.5 Function as an intelligent room thermostat

The Sense I can be used as an intelligent room thermostat for a higher-level control. E.g. a Sense II can control 4 heating circuits, with a dedicated Sense I room control on each (without using a wiring module).

The time program is determined by the higher-level control (e.g. Sense II). At the Sense I, the required room temperature can be temporarily changed until the next switching point of the time program. After this, the higher-level control has priority until the setting at the Sense I is changed again.

3 Old electrical and electronic appliances



Electrical or electronic devices that are no longer serviceable must be collected separately and sent for environmentally compatible recycling (in accordance with the European Waste Electrical and Electronic Equipment Directive).

To dispose of old electrical or electronic devices, you should use the return and collection systems put in place in the country concerned.

4 Operation

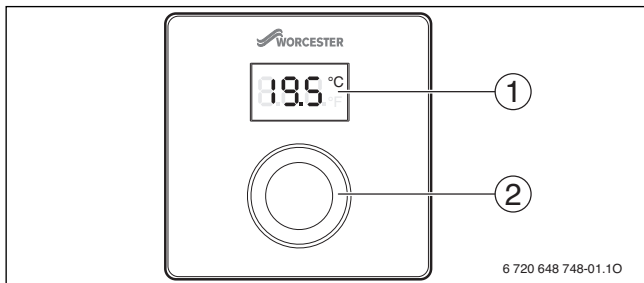









Fig. 1 Overview of control elements

- | | |
|----------|---|
| 1 | Display |
| 2 | Control knob <ul style="list-style-type: none"> • Turn: choose and change settings. • Press: confirm entry or switch display. |

Description of the displays	Example
Current room temperature (standard display)	
Required room temperature: ▶ Press control knob to briefly show the required room temperature (flashing).	
Service display (maintenance required, further information → Service guide) ▶ Press the control knob to switch to the standard display.	
Fault display with fault code and sub code alternating (further information → chapter 6, page 15 and where applicable Service guide) ▶ Press control knob to briefly show the current room temperature.	

Setting the required room temperature	Result
▶ Turn the control knob to set the required room temperature.	
▶ Press the control knob to apply the setting.	

Switch off the heating system	Result
▶ Turn the control knob anti-clockwise to reduce the required room temperature until OFF shows on the display. The setting is applied automatically. When the heating is switched off, frost protection for the room is also switched off. Frost protection of the heat source remains active.	

5 Information for installer

5.1 Mounting

Installation on the wall

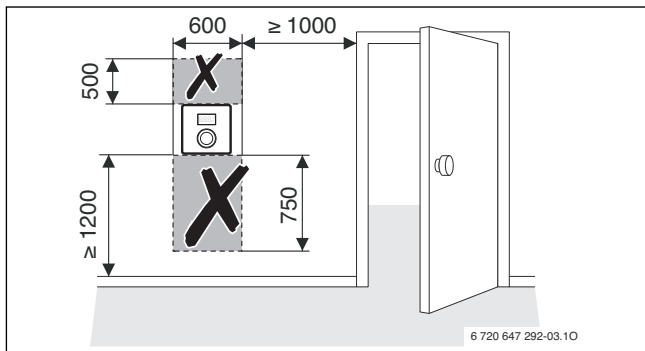

Fig. 2 Selecting suitable installation location on a flat wall

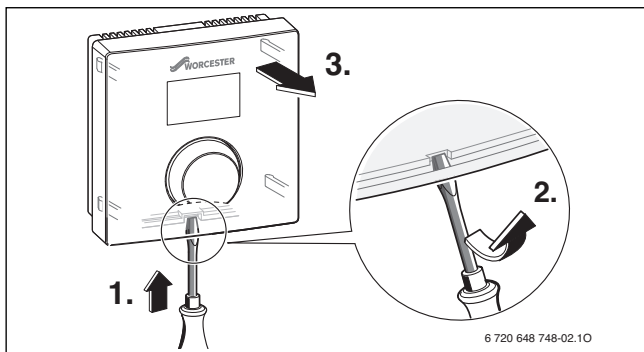

Fig. 3 Removing Sense I from wall base

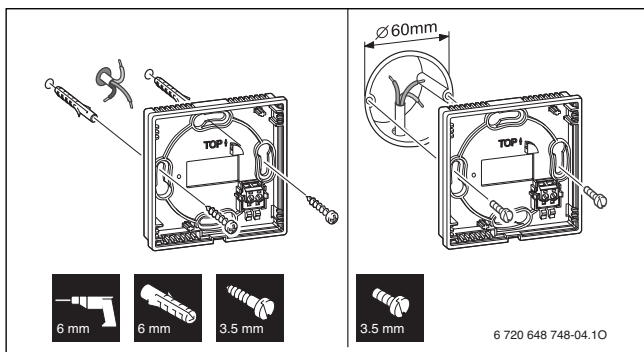

Fig. 4 Installing wall base

Electrical connection

Power is supplied to the user interface via the BUS cable. The polarity of the wires is irrelevant.

- Maintain a minimum clearance (100 mm) between each of the BUS subscribers.

- ▶ Use a cable of at least type H05 VV-... (NYM-J...).
- ▶ In the case of external inductive interferences (e.g. from PV systems), use shielded cables (e.g. LIYCY) and earth the shield on one side. Connect the shield to the building's earthing system, e.g. to a free earth conductor terminal or water pipe.
- ▶ Make sure low-voltage cables are routed separately from mains voltage cables (min. clearance 100 mm).
- ▶ If more than 2 Sense I are going to be installed, a wiring module may be required dependent upon the heat source..
- ▶ If the conductor cross-sections are different, use the junction box to connect the BUS nodes.

Maximum total length of BUS connections:

- ≤ 100 m with conductor cross-section = 0.50 mm^2
- ≤ 300 m with conductor cross-section = 1.50 mm^2

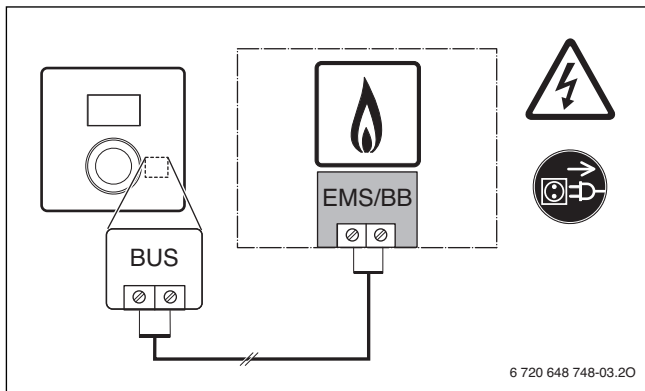







Fig. 5 Making BUS connection between Sense I and boiler

For designation of the BUS connector terminal and further information on the boiler please refer to the technical documentation of the boiler.

5.2 Commissioning

The following tables illustrate Sense I commissioning requirements on installation or first start-up following a reset.

Zone controller with wiring module (systems with several heating circuits without higher-level control)	
<ul style="list-style-type: none"> ▶ Switch system ON/reset Sense I. The Display shows 3 dashes, until the connection to the boiler is established and Sense I asks for heating circuit selection (HC1 appears blinking). 	
<ul style="list-style-type: none"> ▶ Select and confirm heating circuit (H.C = HC1...HC4). ▶ Close the service level. The room temperature is displayed and Sense I works as a zone controller. 	
Room controller (systems with one heating circuit)	
<ul style="list-style-type: none"> ▶ Switch system ON/reset Sense I. The Display shows 3 dashes, until the connection to the boiler is established. 	
<ul style="list-style-type: none"> ▶ Set and confirm A.1 = CO. ▶ Close the service level. The room temperature is displayed and Sense I works as a room controller. 	
Room thermostat (systems with several heating circuits with higher-level control, e. g. Sense II)	
<ul style="list-style-type: none"> ▶ Switch system ON/reset Sense I. The Display shows 3 dashes, until the connection to the boiler is established. 	
<ul style="list-style-type: none"> ▶ Set and confirm A.1 = Fb. ▶ Select and confirm heating circuit (H.C = HC1...HC4). ▶ Close the service level. The room temperature is displayed and Sense I works as a room thermostat. 	

5.3 Settings in the service menu

Overview of settings

Adjustments	Adjustment range ¹⁾	Description
A.1	CO Fb SC	Controller (CO), room thermostat (Fb), zone controller (SC)
H.C	HC1 HC2 HC3 HC4	Heating circuit 1 to 4 ²⁾
d.1	2 3 4	Control characteristics: <ul style="list-style-type: none"> • 2: Fast (for high operating temperature and small volume of heating water) • 3: Average (for radiator heating system and medium operating temperature) • 4: Slow (for underfloor heating system and low operating temperature)
E.1	- 3.0 ... 0.0 ... + 3.0	If the room temperature displayed by the Sense I is wrong, correct the deviation up to $\pm 3\text{ }^{\circ}\text{C}$ ³⁾ .
P.1	4 5	Flow temperature control (4) or load compensation (5)
L.1	1 0	Optimised pump run: pump run time at flow temperature control is maximally shortened. Must be switched off with buffer tanks in the system.
C.1	C F	Unit of displayed temperatures $^{\circ}\text{C}$ (C) or $^{\circ}\text{F}$ (F)
S.1	nF.12.01	Software version ⁴⁾
F.1	1 0	1: Factory settings after reset/power failure 0: System settings maintained after reset/power failure

- 1) Values in bold = default setting
- 2) Only one Sense I can be assigned per heating circuit.
- 3) Temporarily place an appropriate thermometer next to the Sense I for comparative measurement. Keep away from heat sources for 1 hour.
- 4) Turn the control knob to read off the whole value.



Reset or power failure







In the event of a reset (with **F.1** = 1), the Sense I goes back to its standard settings, i. e. it appears after this as a zone controller with all its factory settings.



On restarting after a power failure, the Sense I appears as the previously configured control, i. e. it may also appear as a room thermostat or zone controller with the associated heating circuit allocation.

Operation

The following tables contain examples of how to change a value in the service menu.

Opening the service menu	Result
▶ Press and hold control knob until two dashes appear.	
▶ Release control knob to display the first setting.	

Changing the setting (e.g. heating circuit H.C)	Result
▶ Turn the control knob to select a setting.	
▶ Press control knob to show the current value.	
▶ Press control knob to change the value.	
▶ Turn control knob to set the required value.	
▶ Press the control knob to store the setting.	
▶ Press and hold control knob until the setting is displayed again.	

Closing the service menu	Result
▶ Press and hold control knob until three dashes appear.	
▶ Release control knob. The display changes to the standard display, and the programming unit works with the changed settings.	

6 Troubleshooting

- ▶ If a fault is displayed, record the fault code and the sub code.

If a fault persists:

- ▶ Call your installer or Technical Support (contact 0330 123 3366).
- ▶ Advise type of fault and Serial Number of the Sense I.

6.1 Temperature-related faults

Problem	Cause	Remedy
The required room temperature has not been achieved.	Airlock	Bleed radiators and vent the heating system.
	Time program for the heating circuit	Adjust time program on the higher-level control (e. g. Sense II).
	Flow temperature	Set flow temperature higher.
	Thermostatic valve(s) in reference room	If a thermostatic valve sticks, release thermostatic valve. Fully open the thermostatic valve(s) or ask your contractor to replace them with manual valves.
The room temperature is higher than the set value.	Installation location	Contact an installer to move the Sense I to a suitable location.
The room temperature fluctuates sharply.	Installation location	Contact an installer to move the Sense I to a suitable location.

6.2 Display of a current fault

If a fault occurs the display shows the respective fault code and the 3 digit sub code.

In case of 4 digit sub codes, after displaying the fault code the display shows the first 2 digits and then the last 2 digits of the sub code (e. g.: A21 ... 10 ... 01 ... A21 ... 10 ...).

Fault code	Sub-code	Possible causes and assistance from the contractor
A21	1001	<p>Sense I in heating circuit 1 incorrectly configured.</p> <ul style="list-style-type: none"> ▶ If e.g. a Sense II is installed, set A.1 = Fb (room thermostat) at the Sense I. ▶ If a Greenstar Wiring Center is installed and recognised, set A.1 = SC (zone controller). ▶ If no higher-level control and only one heating circuit is installed, set A.1 = CO (controller).
A22 ... A24	1001	<p>BUS signal from the higher-level control for remote heating control is missing (A22: heating circuit 2, ..., A24: heating circuit 4).</p> <ul style="list-style-type: none"> ▶ E.g. install Sense II. ▶ Make BUS connection.
A61 ... A64	1081 ... 1084	<p>Sense I incorrectly configured (A61/1081: heating circuit 1, ..., A64/1084: heating circuit 4).</p> <ul style="list-style-type: none"> ▶ Set A.1 = Fb (room thermostat).
A61 ... A64	3061 ... 3064	<p>Sense I incorrectly configured (A61/3061: heating circuit 1, ..., A64/3064: heating circuit 4).</p> <ul style="list-style-type: none"> ▶ If e.g. a Sense II is installed, set A.1 = Fb (room thermostat) at the Sense I. ▶ If a Greenstar Wiring Center is installed and recognised, set A.1 = SC (zone controller). ▶ If no higher-level user interface and only one heating circuit is installed, set A.1 = CO (controller).

Fault code	Sub-code	Possible causes and assistance from the contractor
A61 ... A64	3091 ... 3094	Room temperature sensor of the Sense I defective (A61/3091: heating circuit 1, ..., A64/3094: heating circuit 4). ▶ Replace faulty Sense I.
Fill	-	The operating pressure of the heating system is too low. ▶ Top up the heating water (no installer needed, please refer to the technical documentation of the boiler)

Notes



WORCESTER, BOSCH GROUP:

TECHNICAL SUPPORT:	0330 123 3366
APPOINTMENTS:	0330 123 9339
SPARES:	0330 123 9779
LITERATURE:	0330 123 9119
TRAINING:	0330 123 0166
SALES:	0330 123 9669

Worcester, Bosch Group
Cotswold Way, Warndon, Worcester WR4 9SW.
Tel. 0330 123 9559
Worcester, Bosch Group is a brand name of
Bosch Thermotechnology Ltd.
worcester-bosch.co.uk
6 720 648 748

