

# Compress 2000

## System schematic and wiring diagrams

18kW to 30kW.

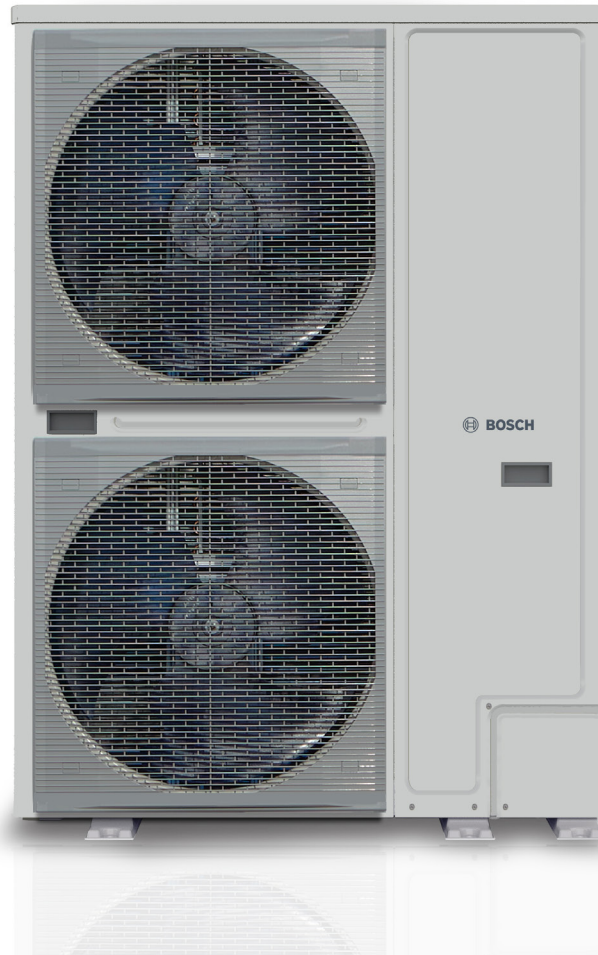



## Compress 2000 18 - 30kW

### Standard systems

### System Wiring

CS2000 AWF R-T open circuit, DHW without buffer

CS2000 AWF R-T multi zone, DHW buffer & 3rd party controls

CS 2000 AWF R-T heating only without buffer















CS2000 AWF R-T heating only multi zone with buffer

### Cascaded

CS2000 AWF R-T- cascaded, DHW, 3rd party controls

CS2000 AWF R-T- cascaded heating only with 3rd party controls



Key	Description
	Antifreeze valve
	T1, T5, Tbt1 sensors
	Isolation valve
	Drain off valve
	Filling valve
	Three port valve
	Magnetic filter
	Non return valve
	3rd party controls
	Pump
	Pressure gauge
	Strainer
	Two port valve <sup>3</sup>
	Immersion heater <sup>3</sup>
	PRV <sup>3</sup>

<sup>1</sup> If required

<sup>2</sup> Immersion heater required for disinfection. If not connected to the heat pump it must be wired to an external time clock

<sup>3</sup> Supplied with cylinder. (Note: 1 two port valve supplied)

CS2000AWF 18 R-T to 30 R-T ensure a minimum system volume of 100L.

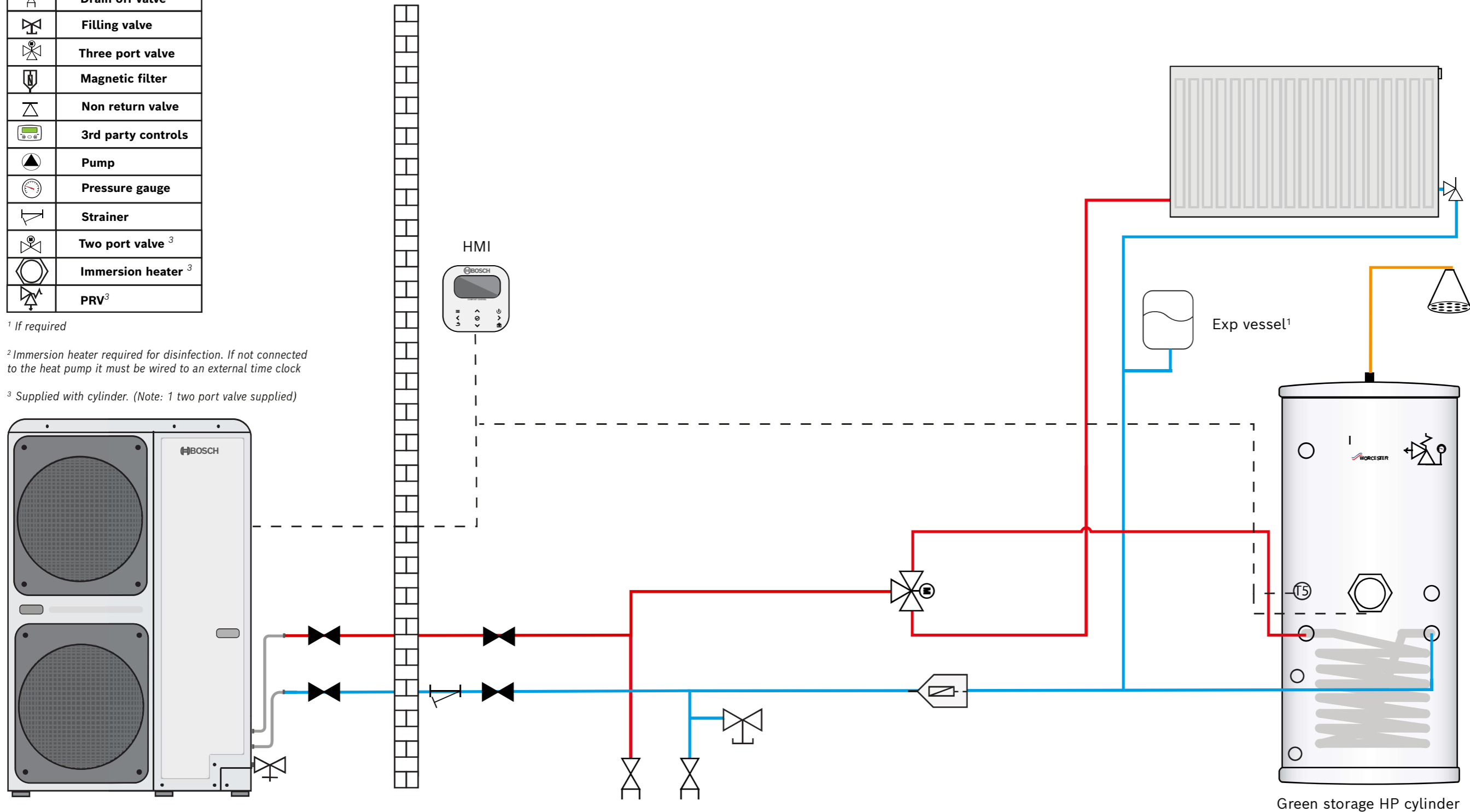

All electrical work should be carried out by a registered engineer. Wiring must comply with the latest IET wiring regulations.

Isolate the mains electricity supply before starting any work and observe all relevant safety precautions. Refer to all relevant product installation manuals for safety and installation instructions.

Whilst it is always our intention to fully assist, it is essential to recognise that all information given by the company is provided in good faith and based upon the information available. Connection labels may not match those of the products installed on site. We recommend that advice should always be checked with your installer, electrician or the manufacturer of the product in question. Consequently, the company cannot be held responsible for any liability relating to the use or repetition of such information or part thereof. In addition, whilst making every reasonable effort to monitor the performance and quality of our supply, installation and service network, we do not accept responsibility for the workmanship or operation of any third party company.

For further information or assistance please contact:  
 Email: [system.design@uk.bosch.com](mailto:system.design@uk.bosch.com) Tel: 01905751464

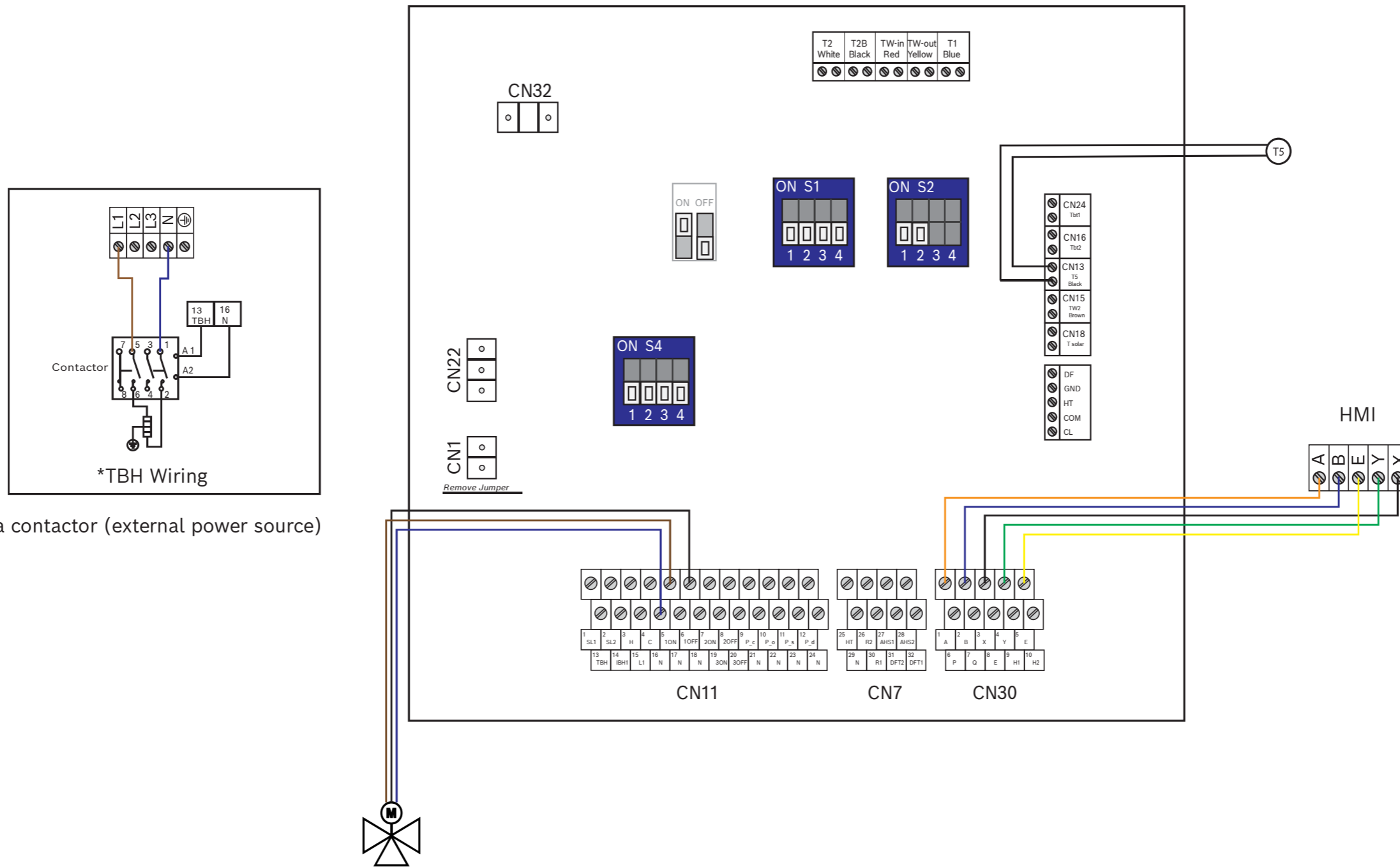

\*TBH Wiring

\*Wired through a contactor (external power source)

If a third party diverter valve is used wiring and orientation may differ. Seek advice for compatible products

All electrical work should be carried out by a registered engineer. Wiring must comply with the latest IET wiring regulations. Isolate the mains electricity supply before starting any work and observe all relevant safety precautions. Refer to all relevant product installation manuals for safety and installation instructions. Whilst it is always our intention to fully assist, it is essential to recognise that all information given by the company is provided in good faith and based upon the information available. Connection labels may not match those of the products installed on site. We recommend that advice should always be checked with your installer, electrician or the manufacturer of the product in question. Consequently, the company cannot be held responsible for any liability relating to the use or repetition of such information or part thereof. In addition, whilst making every reasonable effort to monitor the performance and quality of our supply, installation and service network, we do not accept responsibility for the workmanship or operation of any third party company.



Key	Description
	Antifreeze valve
	T1, T5, Tbt1 sensors
	Isolation valve
	Drain off valve
	Filling valve
	Three port valve
	Magnetic filter
	Non return valve
	3rd party controls
	Pump
	Pressure gauge
	Strainer
	Two port valve <sup>3</sup>
	Immersion heater <sup>3</sup>
	PRV <sup>3</sup>

<sup>1</sup> If required

<sup>2</sup> Immersion heater required for disinfection. If not connected to the heat pump it must be wired to an external time clock

<sup>3</sup> Supplied with cylinder. (Note: 1 two port valve supplied)

CS2000AWF 18 R-T to 30 R-T ensure a minimum system volume of 100L.

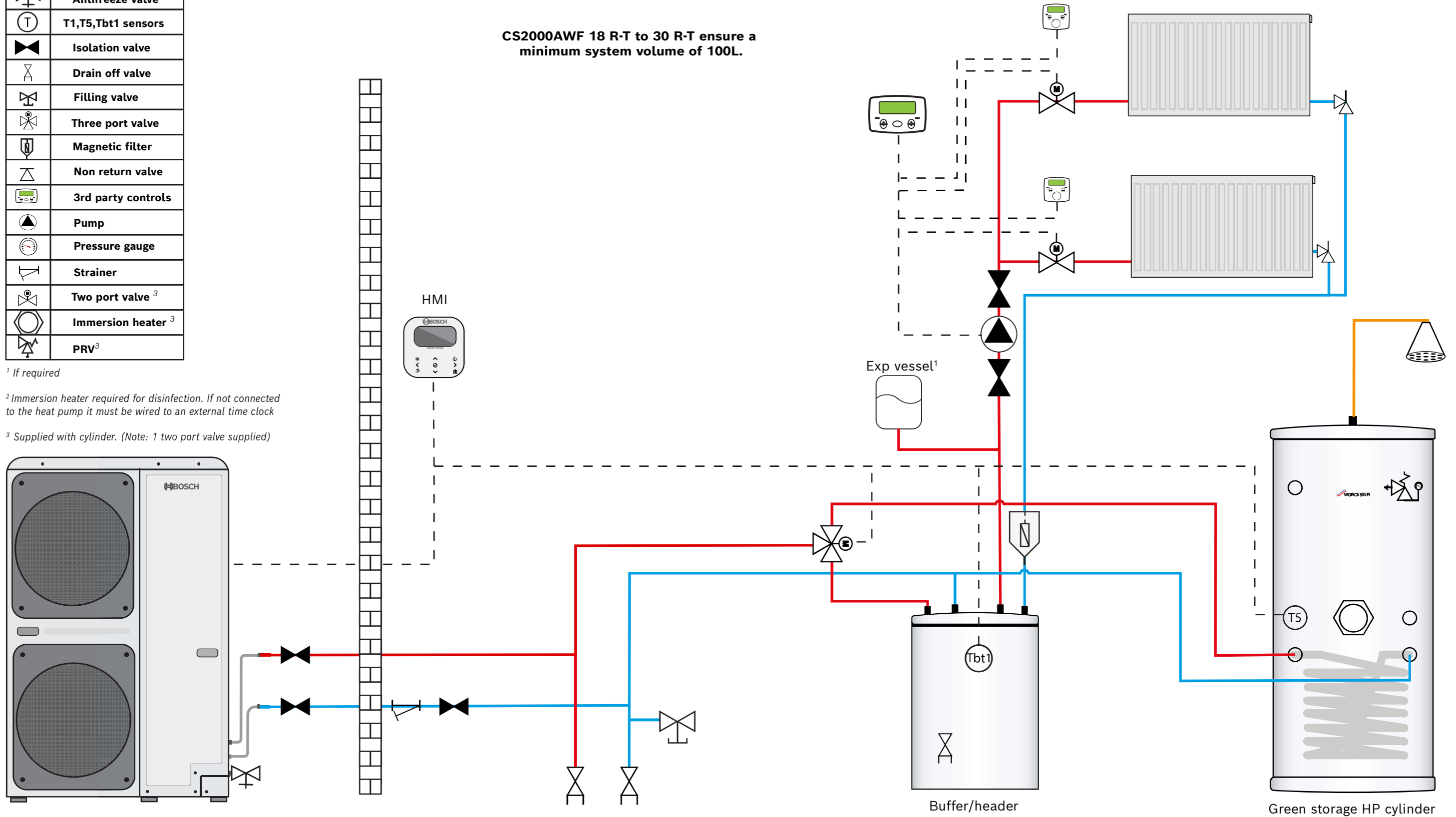

All electrical work should be carried out by a registered engineer. Wiring must comply with the latest IET wiring regulations.

Isolate the mains electricity supply before starting any work and observe all relevant safety precautions. Refer to all relevant product installation manuals for safety and installation instructions.

Whilst it is always our intention to fully assist, it is essential to recognise that all information given by the company is provided in good faith and based upon the information available. Connection labels may not match those of the products installed on site. We recommend that advice should always be checked with your installer, electrician or the manufacturer of the product in question. Consequently, the company cannot be held responsible for any liability relating to the use or repetition of such information or part thereof. In addition, whilst making every reasonable effort to monitor the performance and quality of our supply, installation and service network, we do not accept responsibility for the workmanship or operation of any third party company.

For further information or assistance please contact:  
 Email: [system.design@uk.bosch.com](mailto:system.design@uk.bosch.com) Tel: 01905751464

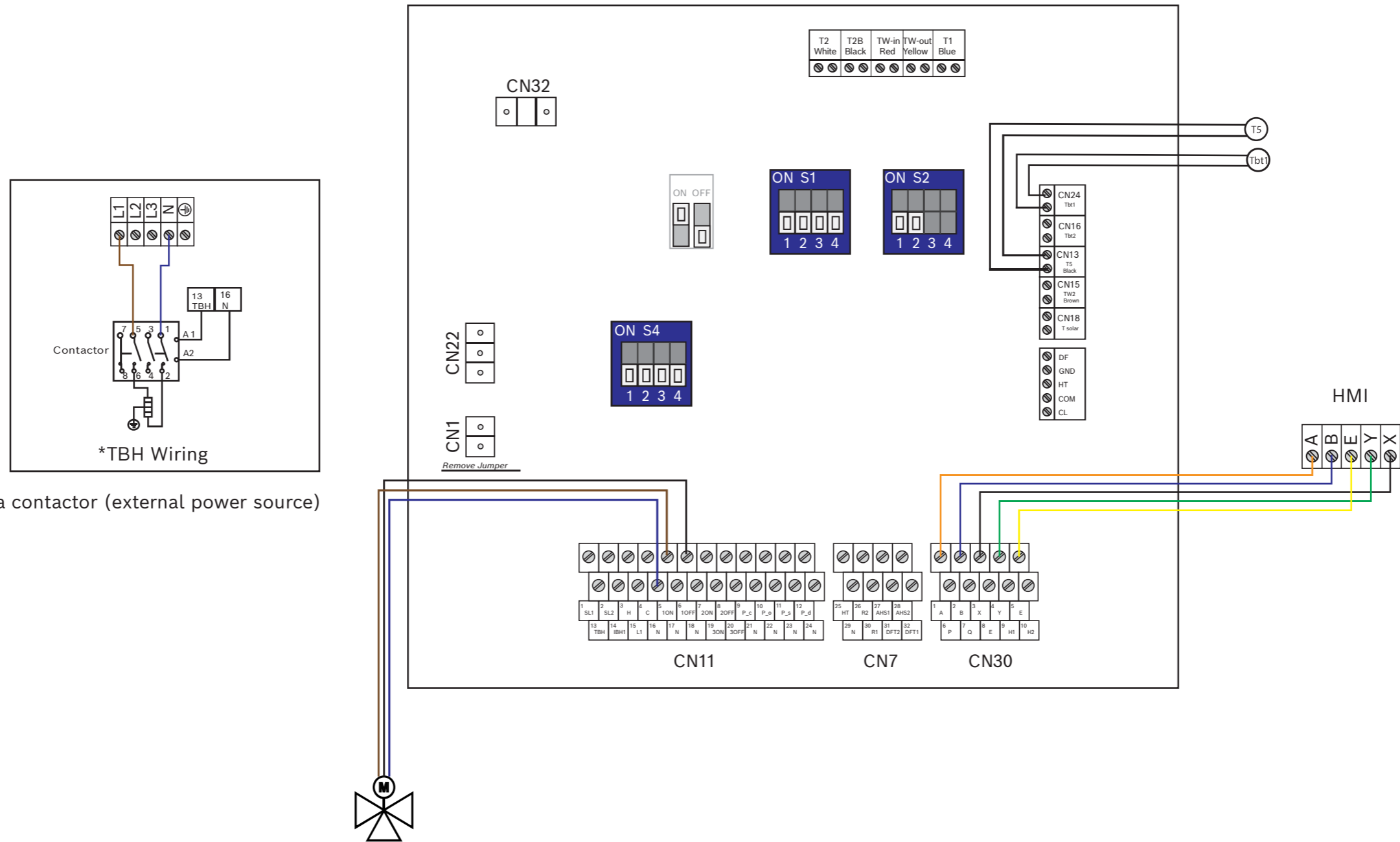







\*Wired through a contactor (external power source)

If a third party diverter valve is used wiring and orientation may differ. Seek advice for compatible products

All electrical work should be carried out by a registered engineer. Wiring must comply with the latest IET wiring regulations. Isolate the mains electricity supply before starting any work and observe all relevant safety precautions. Refer to all relevant product installation manuals for safety and installation instructions. Whilst it is always our intention to fully assist, it is essential to recognise that all information given by the company is provided in good faith and based upon the information available. Connection labels may not match those of the products installed on site. We recommend that advice should always be checked with your installer, electrician or the manufacturer of the product in question. Consequently, the company cannot be held responsible for any liability relating to the use or repetition of such information or part thereof. In addition, whilst making every reasonable effort to monitor the performance and quality of our supply, installation and service network, we do not accept responsibility for the workmanship or operation of any third party company.



Key	Description
	Antifreeze Valve
	Isolation Valve
	Drain off Valve
	Filling Valve
	Magnetic Filter
	Pressure gauge
	Strainer

CS2000AWF 4 R-S to 6 R-S ensure a minimum system volume of 30L. CS2000AWF 8 R-S to 16 R-S ensure a minimum system volume of 70L

<sup>1</sup> If required

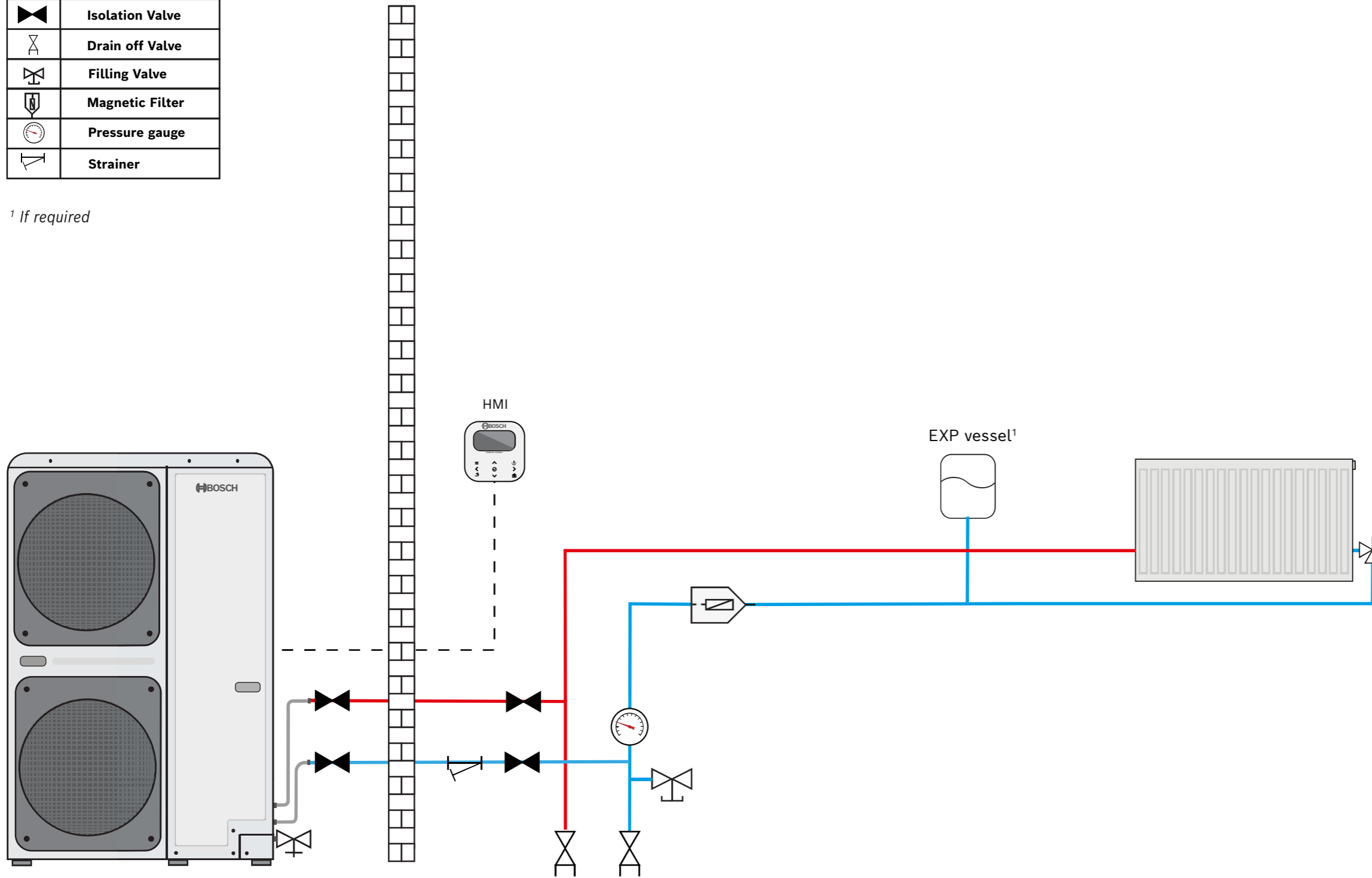

All electrical work should be carried out by a registered engineer. Wiring must comply with the latest IET wiring regulations. Isolate the mains electricity supply before starting any work and observe all relevant safety precautions. Refer to all relevant product installation manuals for safety and installation instructions. Whilst it is always our intention to fully assist, it is essential to recognise that all information given by the company is provided in good faith and based upon the information available. Connection labels may not match those of the products installed on site. We recommend that advice should always be checked with your installer, electrician or the manufacturer of the product in question. Consequently, the company cannot be held responsible for any liability relating to the use or repetition of such information or part thereof. In addition, whilst making every reasonable effort to monitor the performance and quality of our supply, installation and service network, we do not accept responsibility for the workmanship or operation of any third party company.

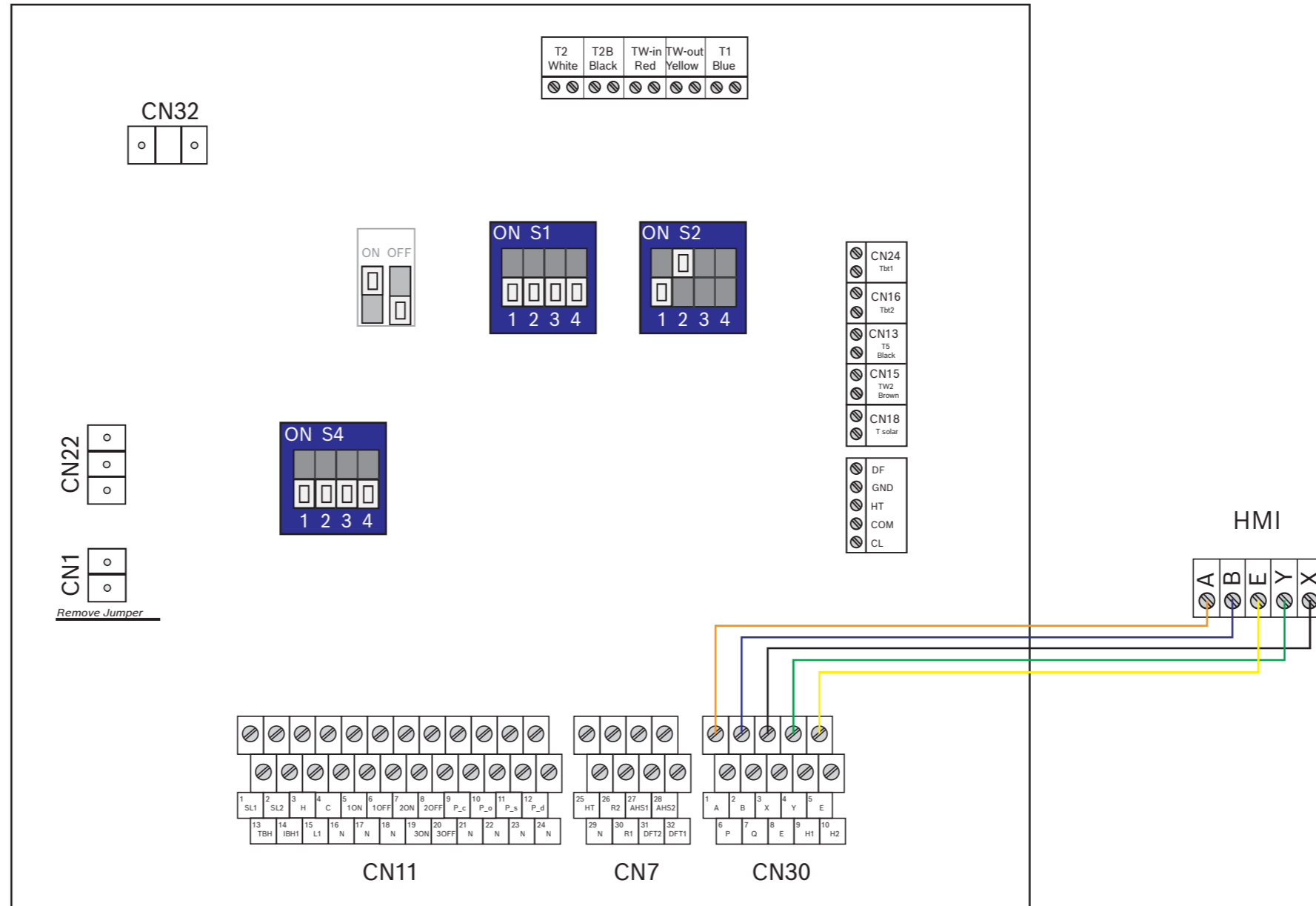

All electrical work should be carried out by a registered engineer. Wiring must comply with the latest IET wiring regulations.

Isolate the mains electricity supply before starting any work and observe all relevant safety precautions. Refer to all relevant product installation manuals for safety and installation instructions.













Whilst it is always our intention to fully assist, it is essential to recognise that all information given by the company is provided in good faith and based upon the information available. Connection labels may not match those of the products installed on site. We recommend that advice should always be checked with your installer, electrician or the manufacturer of the product in question. Consequently, the company cannot be held responsible for any liability relating to the use or repetition of such information or part thereof. In addition, whilst making every reasonable effort to monitor the performance and quality of our supply, installation and service network, we do not accept responsibility for the workmanship or operation of any third party company.

For further information or assistance please contact:

Email: [system.design@uk.bosch.com](mailto:system.design@uk.bosch.com) Tel: 01905751464





Key	Description
	Antifreeze valve
	T1, T5, Tbt1 sensors
	Isolation valve
	Drain off valve
	Filling valve
	Three port valve
	Magnetic filter
	Non return valve
	3rd Party controls
	Pump
	Pressure gauge
	Strainer
	Two port valve

<sup>1</sup> If required

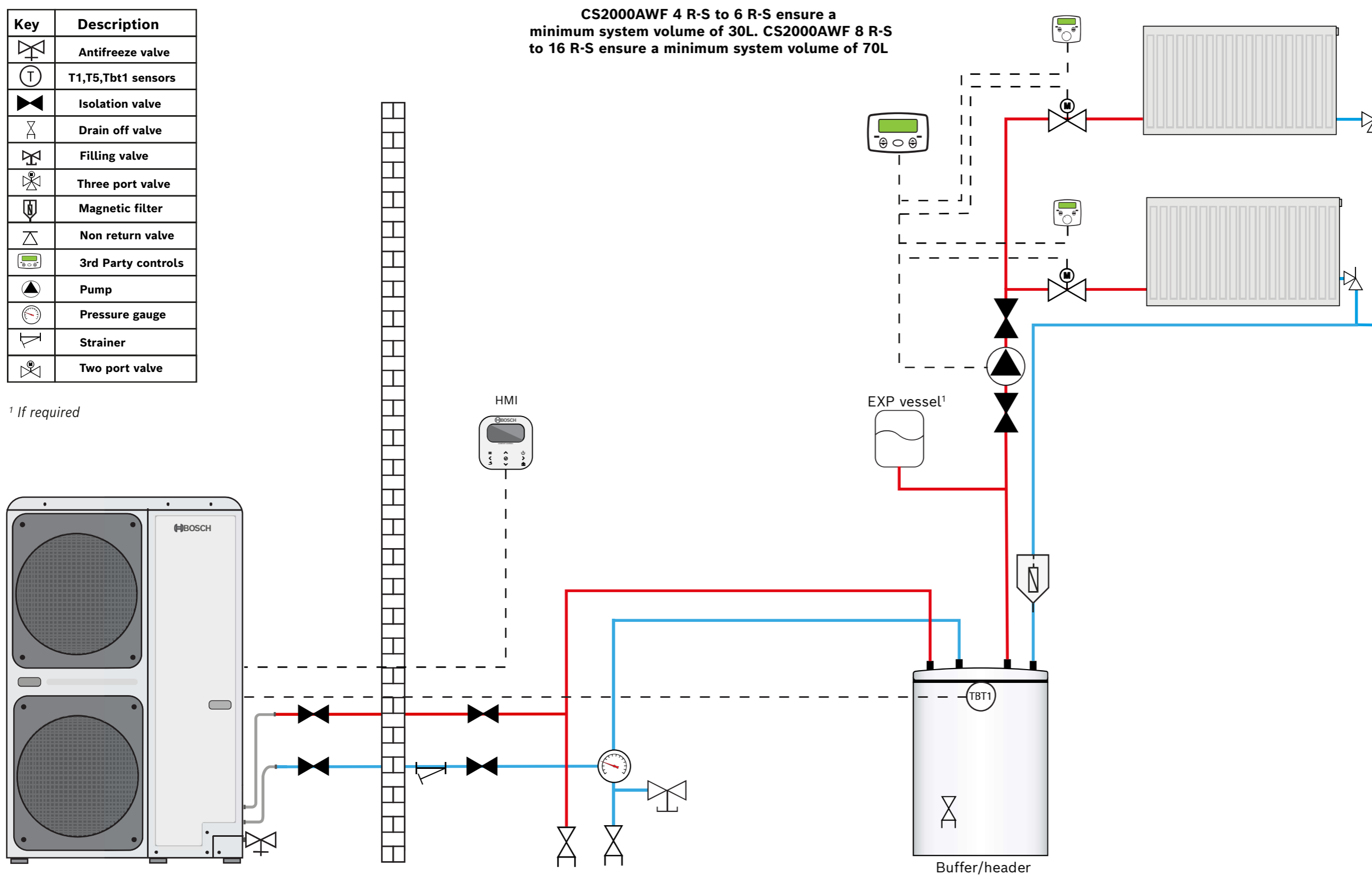

All electrical work should be carried out by a registered engineer. Wiring must comply with the latest IET wiring regulations. Isolate the mains electricity supply before starting any work and observe all relevant safety precautions. Refer to all relevant product installation manuals for safety and installation instructions. Whilst it is always our intention to fully assist, it is essential to recognise that all information given by the company is provided in good faith and based upon the information available. Connection labels may not match those of the products installed on site. We recommend that advice should always be checked with your installer, electrician or the manufacturer of the product in question. Consequently, the company cannot be held responsible for any liability relating to the use or repetition of such information or part thereof. In addition, whilst making every reasonable effort to monitor the performance and quality of our supply, installation and service network, we do not accept responsibility for the workmanship or operation of any third party company.

For further information or assistance please contact:  
 Email: [system.design@uk.bosch.com](mailto:system.design@uk.bosch.com) Tel: 01905751464

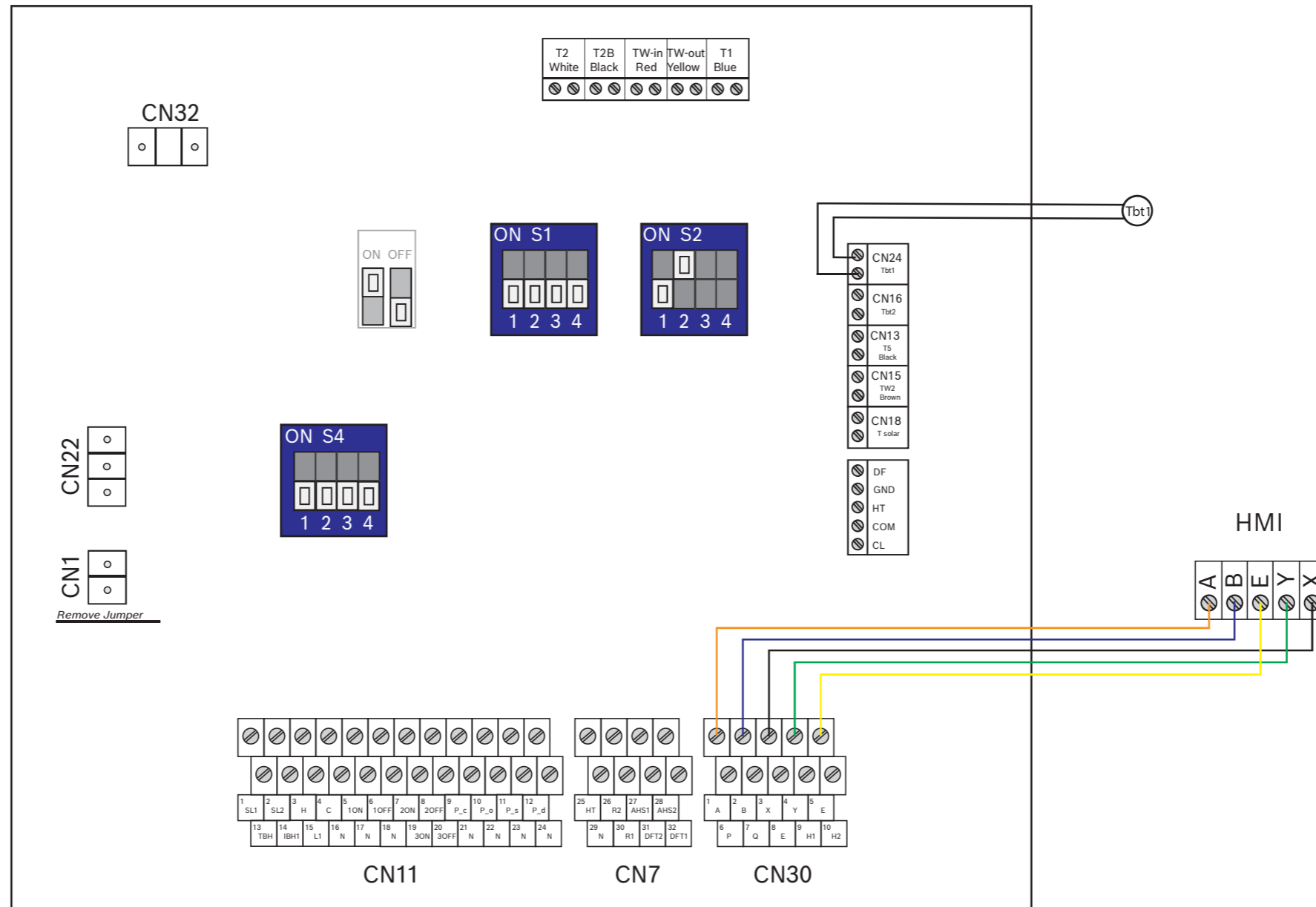

















All electrical work should be carried out by a registered engineer. Wiring must comply with the latest IET wiring regulations.

Isolate the mains electricity supply before starting any work and observe all relevant safety precautions. Refer to all relevant product installation manuals for safety and installation instructions.

Whilst it is always our intention to fully assist, it is essential to recognise that all information given by the company is provided in good faith and based upon the information available. Connection labels may not match those of the products installed on site. We recommend that advice should always be checked with your installer, electrician or the manufacturer of the product in question. Consequently, the company cannot be held responsible for any liability relating to the use or repetition of such information or part thereof. In addition, whilst making every reasonable effort to monitor the performance and quality of our supply, installation and service network, we do not accept responsibility for the workmanship or operation of any third party company.

For further information or assistance please contact:  
 Email: [system.design@uk.bosch.com](mailto:system.design@uk.bosch.com) Tel: 01905751464



Key	Description
	Antifreeze valve
	T1, T5, Tbt1 sensors
	Isolation valve
	Drain off valve
	Filling valve
	Three port valve
	Magnetic filter
	Non return valve
	3rd Party controls
	Pump
	Pressure gauge
	Strainer
	Two port valve <sup>3</sup>
	Immersion heater <sup>3</sup>
	PRV <sup>3</sup>
	DPV

CS2000AWF 18 R-T to 30 R-T ensure a minimum system volume of 100L (Add 50% of the Primary unit to total for each additional unit in system)  
 E.g. Primary = 100L  
 1 additional = 150L  
 2 additional = 200L

<sup>1</sup> If required

<sup>2</sup> Immersion heater required for disinfection. If not connected to the heat pump it must be wired to an external time clock

<sup>3</sup> Supplied with cylinder. (Note: 1 Two port valve supplied)

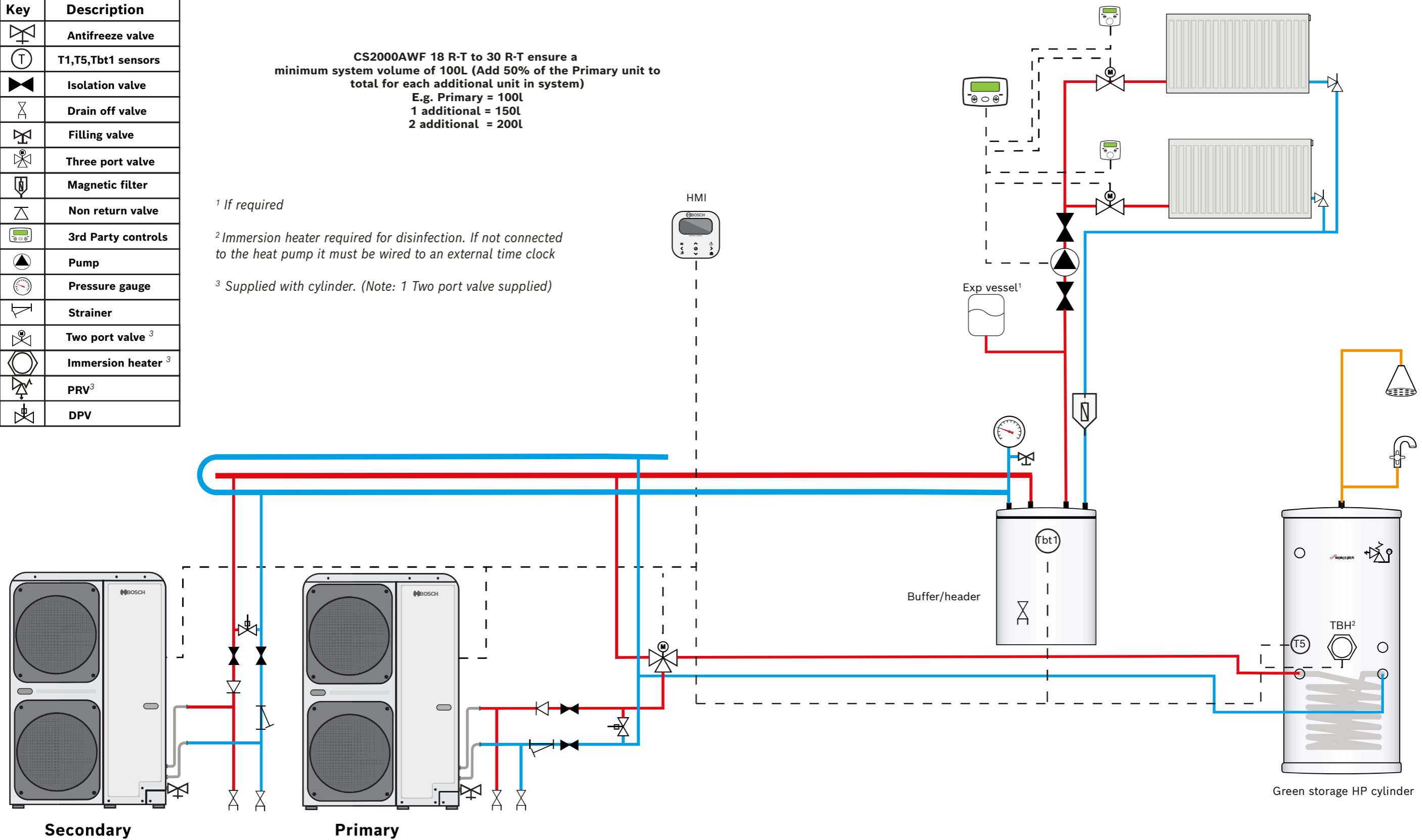

All electrical work should be carried out by a registered engineer. Wiring must comply with the latest IET wiring regulations.

Isolate the mains electricity supply before starting any work and observe all relevant safety precautions. Refer to all relevant product installation manuals for safety and installation instructions.

Whilst it is always our intention to fully assist, it is essential to recognise that all information given by the company is provided in good faith and based upon the information available. Connection labels may not match those of the products installed on site. We recommend that advice should always be checked with your installer, electrician or the manufacturer of the product in question. Consequently, the company cannot be held responsible for any liability relating to the use or repetition of such information or part thereof. In addition, whilst making every reasonable effort to monitor the performance and quality of our supply, installation and service network, we do not accept responsibility for the workmanship or operation of any third party company.

For further information or assistance please contact:  
 Email: [system.design@uk.bosch.com](mailto:system.design@uk.bosch.com) Tel: 01905751464



## Primary

## Secondary

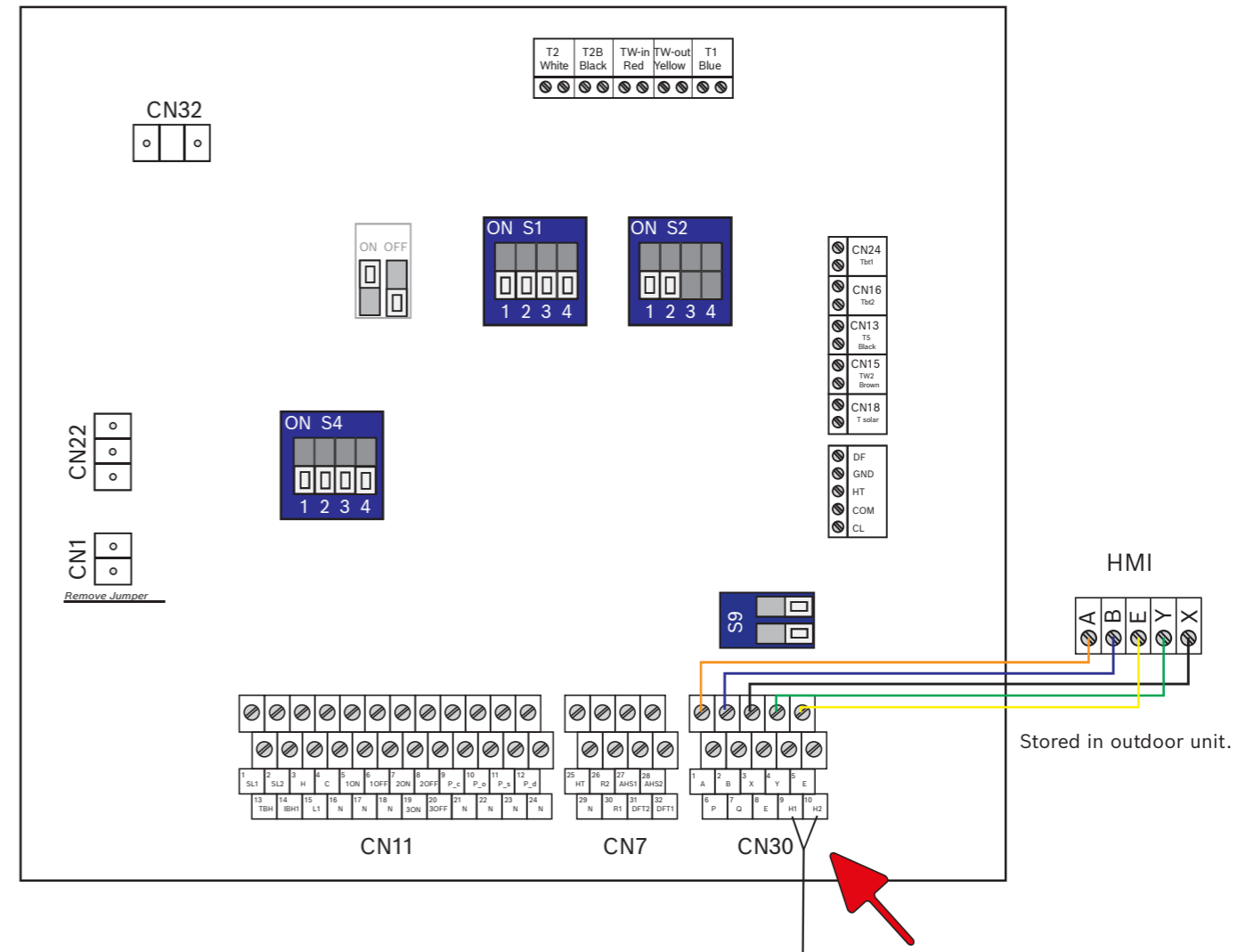
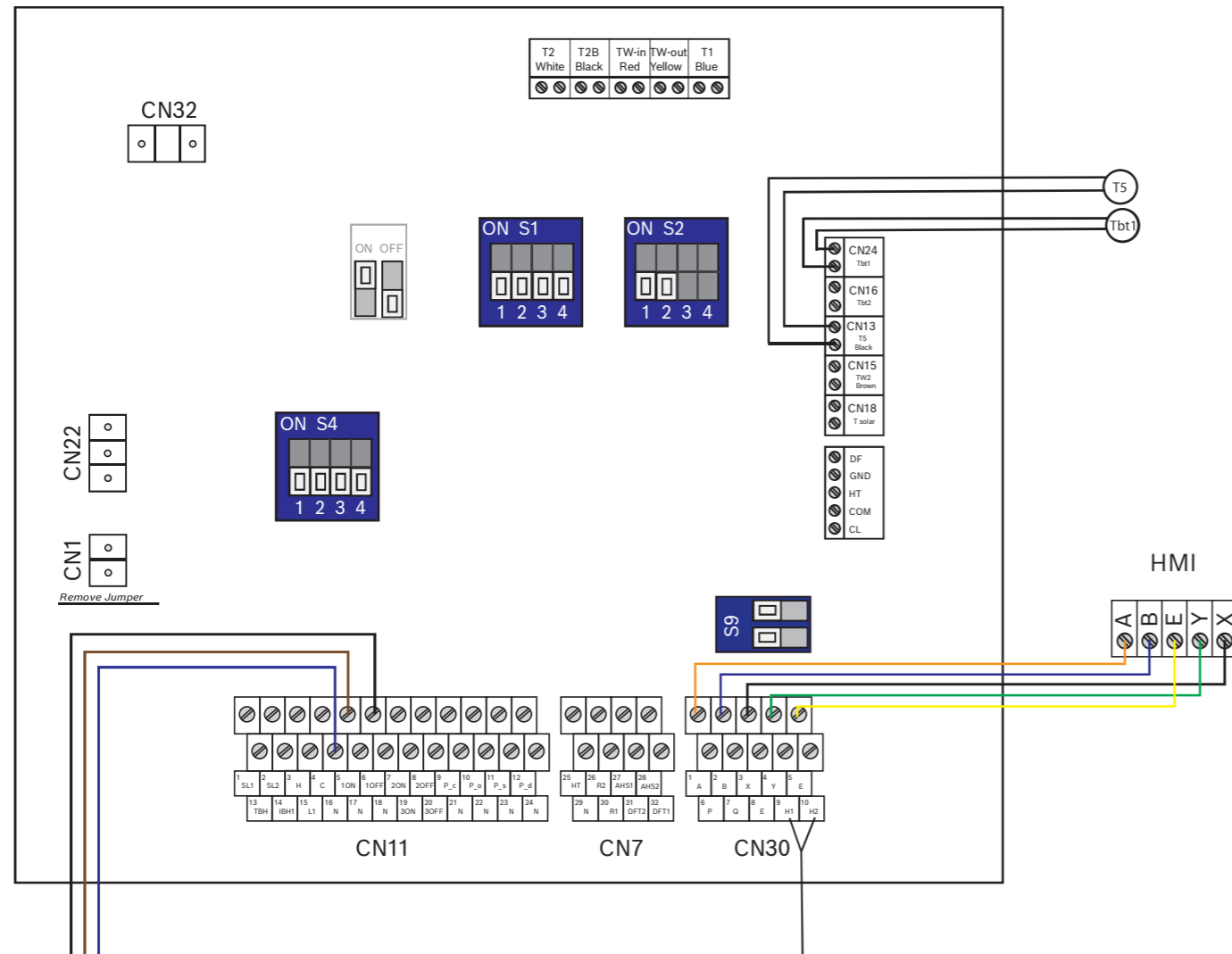

Shielded cable to be used for communication (Shielding must be earthed)

If a third party diverter valve is used wiring and orientation may differ. Seek advice for compatible products

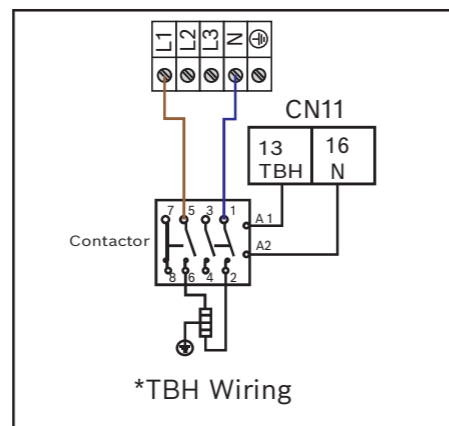

\*Wired through a contactor (external power source)

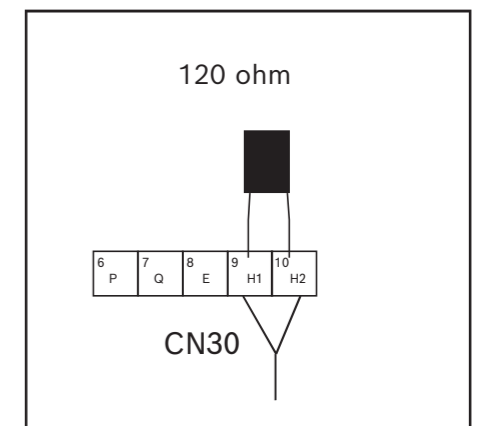

\*Connect 120 ohm resistor provided to the final unit in cascade.

All electrical work should be carried out by a registered engineer. Wiring must comply with the latest IET wiring regulations. Whilst it is always our intention to fully assist, it is essential to recognise that all information given by the company is provided in good faith and based upon the information available. Connection labels may not match those of the products installed on site. We recommend that advice should always be checked with your installer, electrician or the manufacturer of the product in question. Consequently, the company cannot be held responsible for any liability relating to the use or repetition of such information or part thereof. In addition, whilst making every reasonable effort to monitor the performance and quality of our supply, installation and service network, we do not accept responsibility for the workmanship or operation of any third party company.

Key	Description
	Antifreeze valve
	T1, T5, Tbt1 sensors
	Isolation valve
	Drain off valve
	Filling valve
	Three port valve
	Magnetic filter
	Non return valve
	3rd Party controls
	Pump
	Pressure gauge
	Strainer
	Two port valve
	Immersion heater
	PRV
	DPV

CS2000AWF 18 R-T to 30 R-T ensure a minimum system volume of 100L (Add 50% of the Primary unit to total for each additional unit in system)  
 E.g. Primary = 100L  
 1 additional = 150L  
 2 additional = 200L

<sup>1</sup> If required

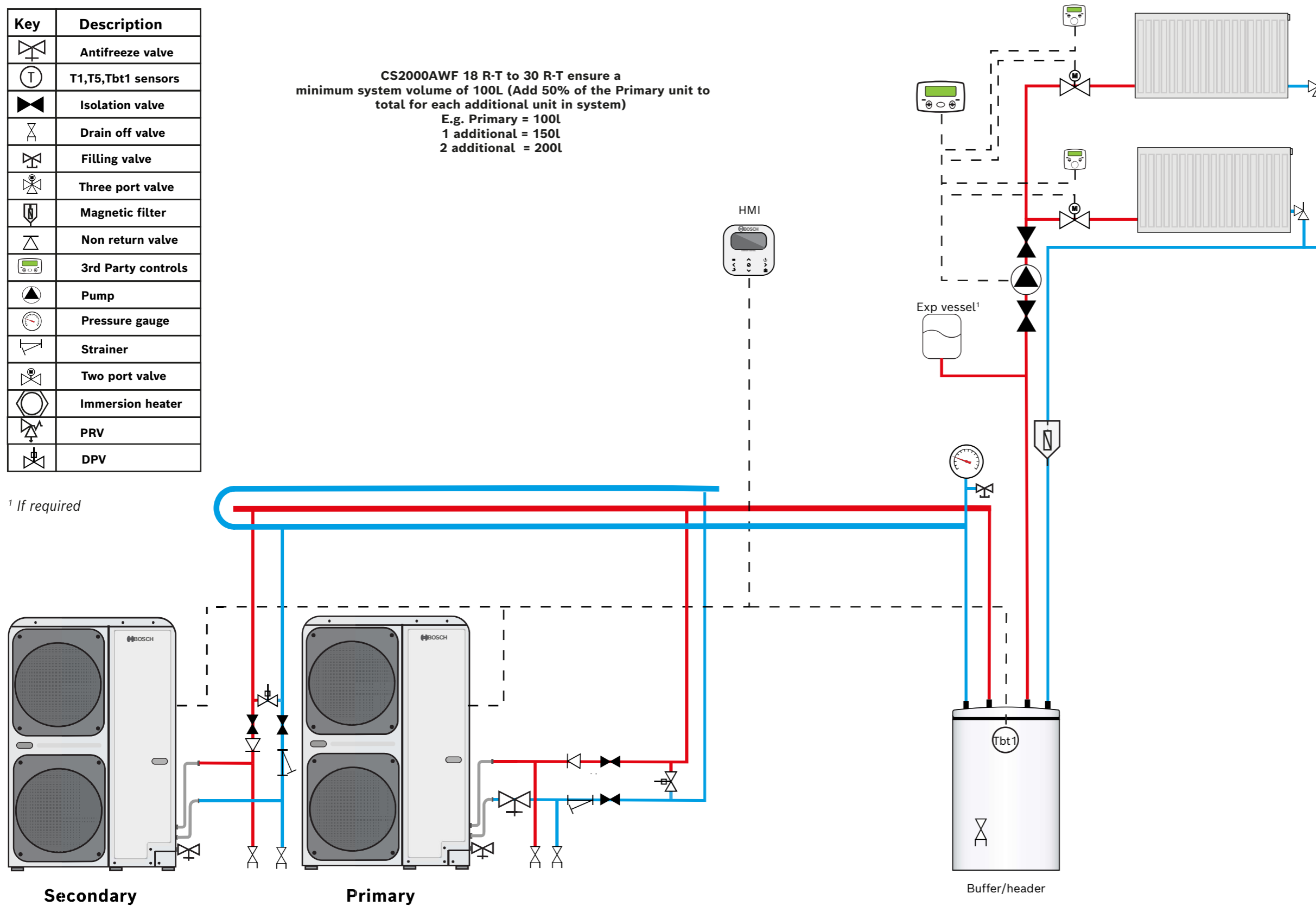

All electrical work should be carried out by a registered engineer. Wiring must comply with the latest IET wiring regulations. Isolate the mains electricity supply before starting any work and observe all relevant safety precautions. Refer to all relevant product installation manuals for safety and installation instructions. Whilst it is always our intention to fully assist, it is essential to recognise that all information given by the company is provided in good faith and based upon the information available. Connection labels may not match those of the products installed on site. We recommend that advice should always be checked with your installer, electrician or the manufacturer of the product in question. Consequently, the company cannot be held responsible for any liability relating to the use or repetition of such information or part thereof. In addition, whilst making every reasonable effort to monitor the performance and quality of our supply, installation and service network, we do not accept responsibility for the workmanship or operation of any third party company.



## Primary

## Secondary

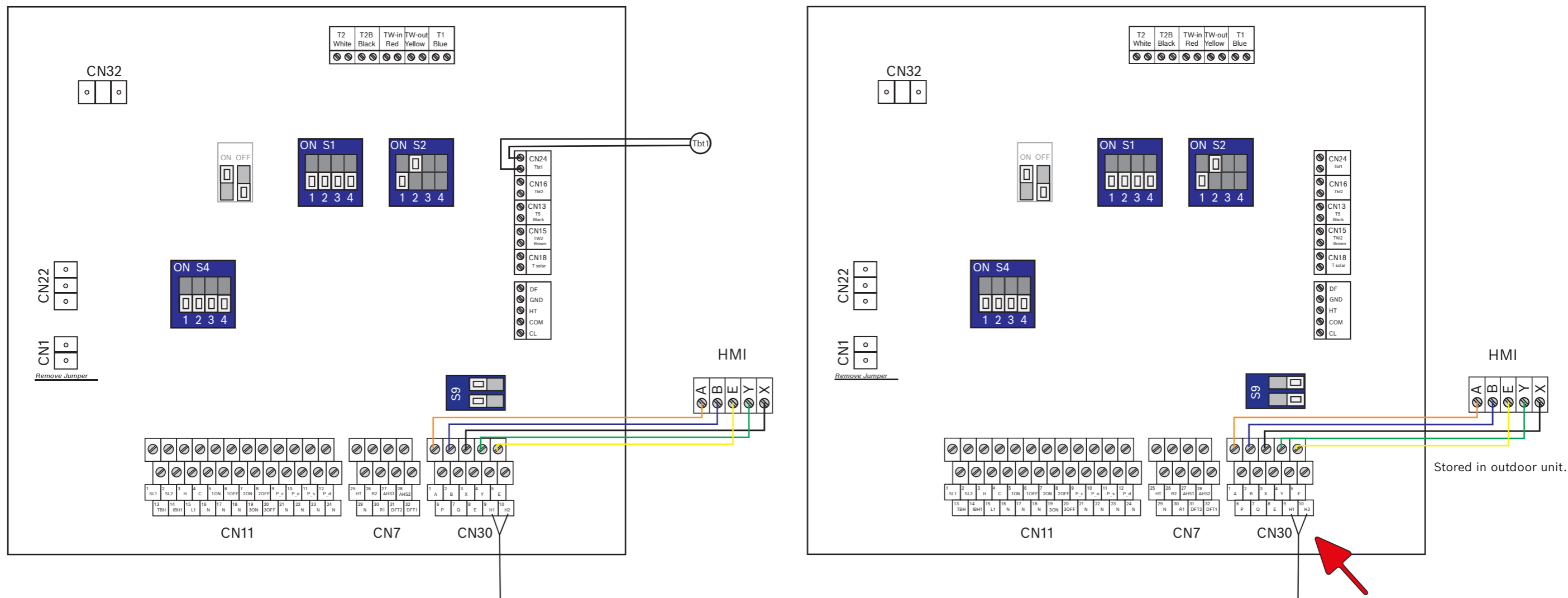

Shielded cable to be used for communication (Shielding must be earthed)

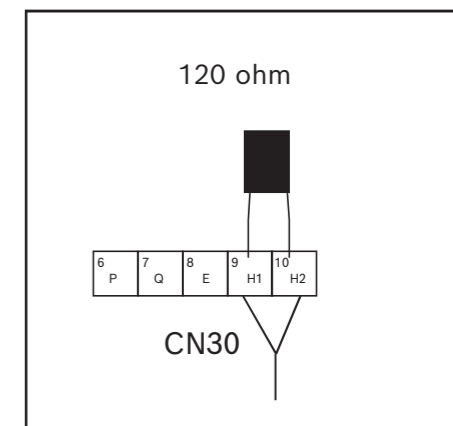

\*Connect 120 ohm resistor provided to the final unit in cascade.

All electrical work should be carried out by a registered engineer. Wiring must comply with the latest IET wiring regulations.

Isolate the mains electricity supply before starting any work and observe all relevant safety precautions. Refer to all relevant product installation manuals for safety and installation instructions.

Whilst it is always our intention to fully assist, it is essential to recognise that all information given by the company is provided in good faith and based upon the information available. Connection labels may not match those of the products installed on site. We recommend that advice should always be checked with your installer, electrician or the manufacturer of the product in question. Consequently, the company cannot be held responsible for any liability relating to the use or repetition of such information or part thereof. In addition, whilst making every reasonable effort to monitor the performance and quality of our supply, installation and service network, we do not accept responsibility for the workmanship or operation of any third party company.

For further information or assistance please contact:

Email: [system.design@uk.bosch.com](mailto:system.design@uk.bosch.com) Tel: 01905751464